

DMAX®

POWER and HAND TOOLS

32
YEARS

2026

LIMITED EDITION

Ürün ve Fiyat Listesi



www.dmaxtools.com

Power in Your Hands



Power in Your Hands

TR **DMAX**®

POWER and HAND TOOLS

**Başarıyı üreten ekipler, geleceği
şekillendirir.
Gücümüz insan kaynaklarından
hedefimiz ise
mükemmeliyetten gelir.**

1994
Firma
Temelleri
Atıldı

2009
Çin
Ofisimiz
Kuruldu

2020
Yerli
Üretim
Başladı

2020
Uluslararası
Üretim ve
İthalat

2024
Kurumsal
Dönüşüm
Başladı

2025
Bayilik ve
Dijital
Altyapı

2026
Elektrikli
El Aletleri
Yatırımı

2026
Servis
Ağı
Genişlemesi



2027
Global
Açılım

2028
Marka
Gücü

2029
Üretim
Liderliği

2032
Teknolojik
Entegrasyonu

2035
Küresel
Oyuncu

www.dmaxtools.com

HAKKIMIZDA

Türkiye'nin Güvenilir El Aleti Markası

Ölçüm ve kesim el aletleri alanında geliştirdiği ürünlerle Hırdavat ve Yapı sektörünün ihtiyaçlarına modern çözümler sunan yerli ve milli bir Türk markasıdır. Şerit metreler, Maket bıçakları ve Profesyonel el aletleri kategorilerinde uzmanlaşan **DMAX** markası, kullanıcı deneyimini merkeze alan yaklaşımıyla sektörün değişen ihtiyaçlarına yenilikçi çözümler üretmektedir.

1994 yılından bu yana pazarda edindiği deneyim ve üretim gücüyle büyüyen marka, bugün **DMAX Global Dış Ticaret Ltd. Şti.** çatısı altında üretim, ithalat ve dağıtım faaliyetlerini güçlü bir kurumsal yapı ile sürdürmektedir. İstanbul Arnavutköy' de bulunan üretim ve lojistik altyapısı sayesinde **DMAX**, üretimden dağıtıma kadar tüm süreçleri profesyonel bir organizasyon ile yönetmektedir. Teknolojik gelişmeleri yakından takip eden **DMAX**; modern üretim teknikleri, kaliteli malzeme kullanımı ve sürdürülebilir üretim anlayışı ile dayanıklı, verimli ve kullanıcı dostu ürünler geliştirmektedir.

VİZYONUMUZ

DMAX Yapı Market ve Hırdavat sektöründe üretici ve ithalatçı kimliğiyle güçlü bir tedarikçi olma misyonunu benimsemektedir. Sürekli gelişim ve inovasyon anlayışıyla hareket eden marka, kullanıcıların ihtiyaçlarını karşılayan kaliteli ürünleri rekabetçi çözümlerle sunmayı hedeflemektedir.

HEDEFLERİMİZ

Elektrikli El Aletleri sektöründe gerçekleştireceği yeni yatırımlar ile ürün gamını genişletmeyi planlayan **DMAX**, hem Türkiye'de hem de uluslararası pazarlarda marka gücünü artırmayı ve sektörde güvenilir bir global marka olma yolunda ilerlemeyi amaçlamaktadır.

TR DMAX®

POWER and HAND TOOLS



1994 yılında atılan ilk adım, bugün güçlü bir Üretim, tedarik ve global ticaret yapısına dönüşmüş durumda. Bu yolculuk, sadece büyümenin değil; doğru zamanda doğru kararlar almanın ve sahadan kopmadan ilerlemenin bir sonucudur. DMAX olarak biz, üretimin içinden gelen bir markayız. Şerit metre ve maket bıçağı üretimimizle başlayan bu yapı, bugün elektrikli el aletleri grubuna yaptığımız yatırımlarla daha geniş bir vizyona ulaşmıştır. Çin bulunan ithalat, ihracat şirketimiz, dış ticaret gücümüz ve gelişmiş tedarik altyapımızla sınırları aşan bir sistem kurduk. Dijitalleşmeyi bir tercih değil, zorunluluk olarak gördük. B2B altyapımız, yıllık bayilik sözleşmelerimiz ve entegre iş modelimizle iş ortaklarımız için hızlı, şeffaf ve sürdürülebilir bir ticaret zemini oluşturduk. Bugün geldiğimiz noktada DMAX; sadece ürün sunan değil, sistem kuran, kârlılık ve sürdürülebilirlik üreten bir hizmet markasıdır. Biz, ölçülebilir gücü yönetilebilir ve geliştirilebilir bir yapıya dönüştürüyoruz. Önümüzdeki dönemde hedefimiz; Türkiye’de kurduğumuz bu yapıyı global pazarlarda daha güçlü bir konuma taşımak ve DMAX’i uluslararası ölçekte tercih edilen bir marka haline getirmektir.

Bu yolculukta bizimle birlikte yürüyen tüm iş ortaklarımıza ve emeği geçen tüm ekip arkadaşlarımıza teşekkür ederiz.

DMAX GLOBAL

DIŞ TİCARET LTD. ŞTİ.

İÇİNDEKİLER

ÜRÜN	SAYFA
Akülü Matkaplar ve Darbeli Matkaplar	10-14
Akülü Darbeli Vidalama / Somun Sıkma - Sökme	15-17
Akülü Elektropnömatik Kırıcı - Deliciler	18
Akülü Taşlama Makinesi	19
Akülü Advantage 4'lü Set	20
Batarya ve Şarj Sistemleri	21-22
Darbesiz ve Darbeli Matkaplar	23-24
Darbeli Somun Sıkma - Sökme	25
Elektropnömatik Kırıcı - Deliciler	26
Avuç Taşlama ve Polisaj Makineleri	27-30
Dekupaj ve Tilki Kuyruğu Testereler	31-32
Sunta ve Profil Kesme Makineleri	33
Sıcak Hava Tabancaları	34
Boya v Harç Karıştırıcılar	35
Zımpara Makineleri	36-37
Üfleme - Vakum ve Boya Püskürtme	38
Tezgah Üstü Testere	39
Şerit Metreler	42-43
Maket Bıçakları	44-47
Bagaj Lastiği	48
Sds Uçlar ve Keskiiler	50-51
Panç ve Buat Açma Ürünleri	52-53
Matkap Uçları	54-58
Mandren ve Setler	59
Bits Uçlar ve Adaptörler	60-62
Kesici Disk ve Testereler	63-65
Zımpara ve Polisaj Ürünleri	66-67
Krikolar	68
Fırça ve Spatulalar	69-71
Su Terazileri ve Ölçüm Aletleri	72-73
Kemer Delme Pense, Boru Kesme Makas ve Kaynak Pense	74-75
Boya ve Yağlama Ekipmanları	76
Hava Tabancaları	77
Hava Kompresör ve Pompalar	78-82
Cırt Kelepçe ve Metal Kelepçe	82-83
Asma Kilitler	84-85
Motor ve Bisiklet Kilitleri	86-87
Yağmurluklar	89
Mengene ve İşkenceler	90-91
Pürmüz ve Lehim Ürünleri	92
Bantlar	93-96
Vantuz ve Aparatlar	97
Eğre ve Törpüler	98-100
Sulama Ürünleri	101-103
Bahçe Makasları	104
Testere Ağızları ve Zincirler	105-106
Bahçe Testereleri ve Baltalar	107-111
Terazi ve Kantarlar	112
Multimetre ve Ölçüm Cihazları	113

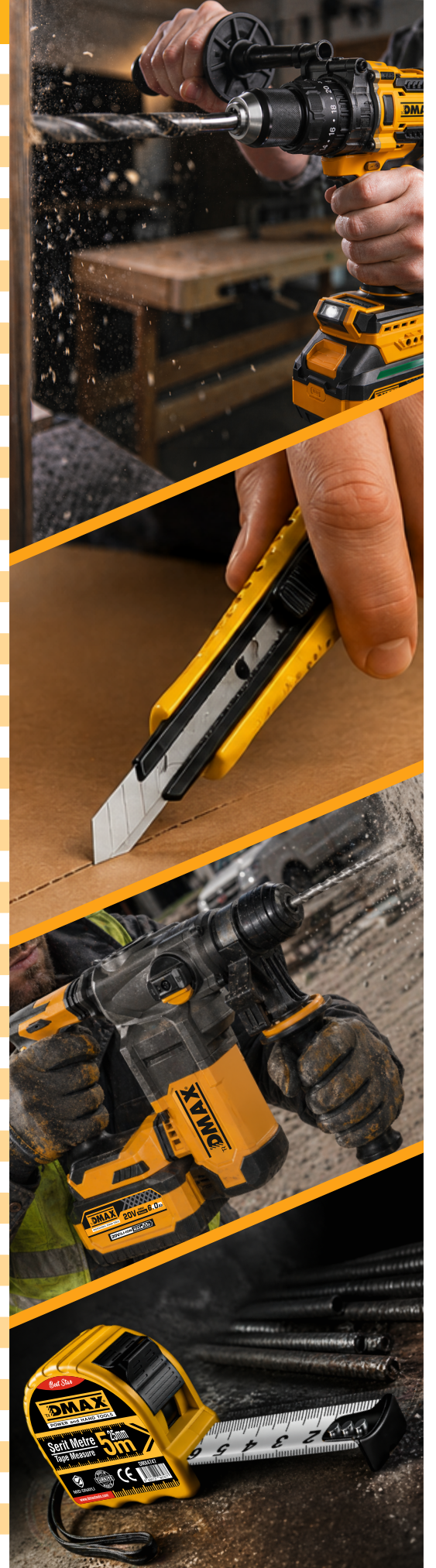



B SADECE
BAYİLERİMİZİN
KULLANIMINA AÇIK
GİRİŞ BİLGİLERİ İÇİN
ÇAĞRI MERKEZİMİZ YA DA
www.dmaxtools.com
ÜZERİNDEN
BAŞVURUDA BULUNABİLİRSİNİZ.



Ürün Bilgileri

- Ayrıntılı Arama
- Stok Durumu
- Teknik Özellikler
- Fiyat Detayları



Sipariş Yönetimi

- Sipariş Oluşturma İşlemleri
- Sipariş İzleme
- Geçmiş Sipariş Kontrolü
- Mevcut Sipariş Bakiyesi
- Proforma Dökümanı



Ödeme Sistemi

- Online Üzerinden Ödeme
- Kredi Kartı ile Ödeme
- Kredi Kartı Taksitli Ödeme
- Hesap Bilgileri Paylaşımı



Kampanya ve Duyuruları

- Sezonluk Kampanyalar
- Stoğa Yeni Gelen Ürünler
- En Çok Satanlar



Hesap Hareketleri

- Güncel Bakiye
- Cari Hesap Ekstresi
- Sipariş Takibi
- Dmax Kur Bilgisi



**Çağrı
Merkezi**

**0 8 5 0
840 92 34**

**BİZİ ARAYIN.
KOLAYCA ERİŞİN.
ZAMANDAN TASARRUF EDİN!**



**KREDİ KARTINA
VADE FARKSIZ
TAKSİT İMKANI**

**+bonus card
9 Taksit**

**KUVEYTÜRK
9 Taksit**

**YapıKredi
9 Taksit**

**AXESS
9 Taksit**

**Paraf
9 Taksit**

**bankkart
9 Taksit**

**AKBANK
9 Taksit**



GÜNCEL
FİYATLAR



GÜVENLİ
ÖDEME



HIZLI
İŞLEM



ÖZEL
KAMPANYALAR



GENİŞ ÜRÜN
YELPAZESİ

Not: Ödeme seçeneklerindeki taksit oranları dönemsel değişmektedir.

TR DMAX®

POWER and HAND TOOLS



**BRUSHLESS
MOTOR**
KÖMÜRSÜZ MOTOR

OYUNDA GÜÇLÜ OLAN KAZANIR
DAHA FAZLA GÜÇ, DAHA FAZLA KONTROL, DAHA FAZLA KAZANÇ.

Power X-Change Family

Dmax Proline Akü Teknolojisi

uyumluluğu sayesinde tüm ürünlerimizi **TEK AKÜ** ile çalıştırabilirsiniz.

TEK AKÜ ile sınırları kaldır!

Uyumlu Sistem.

Kesintisiz Güç.

DMAX 20V SERIES

Akülü Darbeli Matkap

DMX3005

20V 2.0Ah Li-ion 65Nm Tork
Hız - RPM / 0-450/2000 d/dk
Mandren Aralığı / 1.0-13 mm



Akülü Darbeli Matkap

DMX3006

20V 2.0Ah Li-ion 85Nm Tork
Hız - RPM / 0-380/1600/2000 d/dk
Mandren Aralığı / 1.0-13 mm



Akülü Elektropnömatik Kırıcı Delici

DMX3013

20V 6.0Ah Li-ion 3.8 Joule
Hız - RPM / 0-1040 d/dk
Darbe Oranı: 0/4850 bpm



Akülü Elektropnömatik Kırıcı Delici

DMX3012

20V 4.0Ah Li-ion 2.2 Joule
Hız - RPM / 0-1350 d/dk
Darbe Oranı: 0/4500 bpm



Akülü Taşlama Makinesi

DMX3014

20V 4.0Ah Li-ion
Hız - RPM / 0-4000/600
10000 d/dk
Disk Çapı: 115 mm-125 mm



Akülü Darbeli Somun Sıkma-Sökme

DMX3009

20V 4.0Ah Li-ion 850Nm Tork
Hız - RPM / 0-800/1200
1800/2200 d/dk
Mandren Aralığı / 1/2" - 12.7 mm



Batarya Güç Göstergeli



**20V MAX
LITHIUM-ION**

DMX3048



Batarya Güç Göstergeli



**20V MAX
LITHIUM-ION**

DMX3049



Batarya Güç Göstergeli



**20V MAX
LITHIUM-ION**

DMX3050

TR DMAX[®]

PROFESSIONAL POWER TOOLS



Akülü Darbeli Matkap

DMX3006Sağ ve Sol
VidalamaTitreşim
Emici KolYumuşak
KavramaŞarj Dolunca
Otomatik DurdurmaImpact
Drill**85Nm**
TORK GÜCÜ

20+2 Tork Ayarı

Batarya

20V 2.0Ah Li-ion 2 Adet

Hız - RPM / 0-380/1600/2000 d/dk

Mandren Aralığı / 1.0-13 mm

Aşırı Yük Korumalı

Titreşim Emici Kol

Ön Led Aydınlatma

Sağ ve Sol Vidalama

Koli: 4 Adet

**2X** 20V 2.0Ah
BATARYA**50** 2.4A
Dakika Hızlı
ŞarjANAHTARSIZ
METAL MANDREN**20V^{2.0Ah}**
LITHIUM-ION**BRUSHLESS**
MOTOR

KÖMÜRSÜZ MOTOR

MODEL NO: C3221



8 684 727 930066

174 \$

Akülü Darbeli Matkap

DMX3005Sağ ve Sol
VidalamaTitreşim
Emici KolYumuşak
KavramaŞarj Dolunca
Otomatik DurdurmaImpact
Drill**65Nm**
TORK GÜCÜ

18+2 Tork Ayarı

Batarya

20V 2.0Ah Li-ion 2 Adet

Hız - RPM / 0-450/2000 d/dk

Mandren Aralığı / 1.0-13 mm

Aşırı Yük Korumalı

Titreşim Emici Kol

Ön Led Aydınlatma

Sağ ve Sol Vidalama

Koli: 4 Adet

**2X** 20V 2.0Ah
BATARYA**50** 2.4A
Dakika Hızlı
ŞarjANAHTARSIZ
METAL MANDREN**20V^{2.0Ah}**
LITHIUM-ION**BRUSHLESS**
MOTOR

KÖMÜRSÜZ MOTOR

MODEL NO: C3118



8 684 727 930059

146 \$



Akülü Darbeli Matkap

DMX3007

20V 4.0Ah LITHIUM-ION

**Tutma
Kolu**

**BRUSHLESS
MOTOR**
KÖMÜRSÜZ MOTOR

150Nm
TORK GÜCÜ

20+2 Tork Ayarı

**Impact
Drill**



Sağ ve Sol
Vidalama



Titreşim
Emici Kol



Yumuşak
Kavrama

100 2.4A Hızlı
Dakika Şarj

**AUTO
LOCK**

ANAHTARSIZ
METAL MANDREN



Şarj Dolunca
Otomatik Durdurma

Batarya

20V 4.0Ah Li-ion 2 Adet

Hız - RPM / 0-400/1600/2000 d/dk

Mandren Aralığı / 1.0-13 mm

Aşırı Yük Korumalı

Titreşim Emici Kol

Ön Led Aydınlatma

Sağ ve Sol Vidalama

Koli: 4 Adet



2X 20V 4.0Ah
BATARYA

MODEL NO: C3520



816847271930073

264 \$

Akülü Matkap

DMX3001

Sağ ve Sol Vidalama



Titreşim Emici Kol



Yumuşak Kavrama



Şarj Dolunca Otomatik Durdurma

60Nm
TORK GÜCÜ**20+1 Tork Ayarı**

Batarya

16V 2.0Ah Li-ion 2 Adet

Hız - RPM / 0-450/1800 d/dk

Mandren Aralığı / 1.0-10 mm

Aşırı Yük Korumalı

Titreşim Emici Kol

Ön Led Aydınlatma

Sağ ve Sol Vidalama

Koli: 5 Adet

**2X** 20V 2.0Ah
BATARYA**60** 2.0A
Dakika Hızlı ŞarjANAHTARSIZ
METAL MANDREN**16V^{2.0Ah}**
LITHIUM-ION**BRUSHLESS**
MOTOR

KÖMÜRSÜZ MOTOR

MODEL NO: A3117



8 684 727 930011

94 \$

Akülü Darbeli Matkap

DMX3002

Sağ ve Sol Vidalama



Titreşim Emici Kol



Yumuşak Kavrama



Şarj Dolunca Otomatik Durdurma

60Nm
TORK GÜCÜ**20+2 Tork Ayarı**

Batarya

16V 2.0Ah Li-ion 2 Adet

Hız - RPM / 0-450/1800 d/dk

Mandren Aralığı / 1.0-10 mm

Aşırı Yük Korumalı

Titreşim Emici Kol

Ön Led Aydınlatma

Sağ ve Sol Vidalama

Koli: 5 Adet

**2X** 20V 2.0Ah
BATARYA**60** 2.0A
Dakika Hızlı ŞarjANAHTARSIZ
METAL MANDREN**16V^{2.0Ah}**
LITHIUM-ION**BRUSHLESS**
MOTOR

KÖMÜRSÜZ MOTOR

MODEL NO: C3117



8 684 727 930028

97 \$



Akülü Darbeli Torklu Vidalama

16V 2.0Ah LITHIUM-ION

DMX3003
**BRUSHLESS
MOTOR**
 KÖMÜRSÜZ MOTOR

60 **2.0A** **Hızlı**
 Dakika **Şarj**
160Nm
TORK GÜCÜ
 20+2 Tork Ayarı

 Sağ ve Sol
 Vidalama

 Titreşim
 Emici Kol

 Yumuşak
 Kavrama

LED IŞIKLI
GÜÇ BATARYADA

 Şarj Dolunca
 Otomatik Durdurma

KONTROL SENDE

Batarya

16V 2.0Ah Li-ion 2 Adet

Hız - RPM / 0-1300/2400/3300 d/dk

Mandren Aralığı / 1/4" - 0.63 mm

Aşırı Yük Korumalı

Titreşim Emici Kol

Ön Led Aydınlatma

Sağ ve Sol Vidalama

Koli: 5 Adet

2X 20V 2.0Ah
BATARYA
MODEL NO: A1017

8 684 727 930035

113\$

Akülü Matkap

DMX3004

Sağ ve Sol Vidalama



Titreşim Emici Kol



Yumuşak Kavrama



Şarj Dolunca Otomatik Durdurma

Batarya

20V 1.5Ah Li-ion 2 Adet

Hız - RPM / 0-400/1500 d/dk

Mandren Aralığı / 1.0-10 mm

Aşırı Yük Korumalı

Titreşim Emici Kol

Ön Led Aydınlatma

Sağ ve Sol Vidalama

Koli: 10 Adet

26Nm
TORK GÜCÜ

18+1 Tork Ayarı

**2X** 12V 1.5Ah
BATARYA**90** 1.0A
Dakika Hızlı Şarj**12V 1.5Ah**
LITHIUM-ION

MODEL NO: 8613



8 1684727 193004 2

56 \$

Akülü Darbeli Matkap

DMX3000

Sağ ve Sol Vidalama



Titreşim Emici Kol



Yumuşak Kavrama



Şarj Dolunca Otomatik Durdurma

Batarya

20V 1.5Ah Li-ion 2 Adet

Hız - RPM / 0-400/1500 d/dk

Mandren Aralığı / 1.0-10 mm

Aşırı Yük Korumalı

Titreşim Emici Kol

Ön Led Aydınlatma

Sağ ve Sol Vidalama

Koli: 10 Adet

35Nm
TORK GÜCÜ

18+2 Tork Ayarı

**2X** 20V 1.5Ah
BATARYA**50** 1.8A
Dakika Hızlı Şarj**20V 1.5Ah**
LITHIUM-ION

MODEL NO: 8620



8 1684727 193000 4

87 \$



Akülü Darbeli Vidalama Somun Sıkma-Sökme

20V 2.0Ah LITHIUM-ION

DMX3011
**BRUSHLESS
MOTOR**
 KÖMÜRSÜZ MOTOR

220Nm
 TORK GÜCÜ

4 Kademeli Tork Ayarı

50 2.4A Hızlı
 Dakika Şarj

 Şarj Dolunca
 Otomatik Durdurma

 Sağ ve Sol
 Vidalama

 Titreşim
 Emici Kol

 Yumuşak
 Kavrama

Batarya

16V 2.0Ah Li-ion 2 Adet

Hız - RPM / 0-1300/2700/3500/3800 d/dk

Mandren Aralığı / 3/4" - 19 mm-1/4" - 6.35 mm

Aşırı Yük Korunmalı

Titreşim Emici Kol

Ön Led Aydınlatma

Sağ ve Sol Vidalama

Koli: 2 Adet

2X 20V 2.0Ah
 BATARYA

MODEL NO: A1120



816847271930110

210 \$

Akülü Darbeli Somun Sıkma-Sökme

DMX3008**550Nm
TORK GÜCÜ**

4 Kademeli Tork Ayarı

Sağ ve Sol
VidalamaTitreşim
Emici KolYumuşak
KavramaŞarj Dolunca
Otomatik Durdurma

Batarya

20V 4.0Ah Li-ion 2 Adet

Hız - RPM / 0-1000/1500/2150/2700 d/dk

Mandren Aralığı / 1/2" - 12.7 mm

Aşırı Yük Korumalı

Titreşim Emici Kol

Ön Led Aydınlatma

Sağ ve Sol Vidalama

Koli: 3 Adet

**2X** 20V 4.0Ah
BATARYA**20V^{4.0Ah}
LITHIUM-ION****BRUSHLESS
MOTOR**
KÖMÜRSÜZ MOTOR

MODEL NO: A1320



8 684 727 193 008 0

220 \$**100** 2.4A Hızlı
Dakika Şarj

Akülü Darbeli Somun Sıkma-Sökme

DMX3009**850Nm
TORK GÜCÜ**

4 Kademeli Tork Ayarı

Sağ ve Sol
VidalamaTitreşim
Emici KolYumuşak
KavramaŞarj Dolunca
Otomatik Durdurma

Batarya

20V 4.0Ah Li-ion 2 Adet

Hız - RPM / 0-800/1200/1800/2200 d/dk

Mandren Aralığı / 1/2" - 12.7 mm

Aşırı Yük Korumalı

Titreşim Emici Kol

Ön Led Aydınlatma

Sağ ve Sol Vidalama

Koli: 2 Adet

**2X** 20V 4.0Ah
BATARYA**20V^{4.0Ah}
LITHIUM-ION****BRUSHLESS
MOTOR**
KÖMÜRSÜZ MOTOR

MODEL NO: A1420



8 684 727 193 009 1

268 \$**100** 2.4A Hızlı
Dakika Şarj



Akülü Darbeli Somun Sıkma-Sökme

20V 6.0Ah LITHIUM-ION

DMX3010
**BRUSHLESS
MOTOR**
 KÖMÜRSÜZ MOTOR

1600Nm
 TORK GÜCÜ

4 Kademeli Tork Ayarı

 Şarj Dolunca
 Otomatik Durdurma

150 2.4A Hızlı
 Dakika Şarj

 Sağ ve Sol
 Vidalama

 Titreşim
 Emici Kol

 Yumuşak
 Kavrama

Batarya

16V 2.0Ah Li-ion 2 Adet

Hız - RPM / 0-950/1150/1400/1800 d/dk

Mandren Aralığı / 3/4" - 19 mm

Aşırı Yük Korunmalı

Titreşim Emici Kol

Ön Led Aydınlatma

Sağ ve Sol Vidalama

Koli: 2 Adet

**2x 20V 6.0Ah
BATARYA**

MODEL NO: A1520



816847271930103

430 \$

Akülü Elektropnömatik Kırıcı Delici

DMX3012Sağ ve Sol
VidalamaTitreşim
Emici KolYumuşak
Kavrama

Impact Drill

2.2 Joule
DARBE GÜCÜ

4 Kademeli Hız Ayarı

Şarj Dolunca
Otomatik DurdurmaSDS
Plus

Batarya

20V 4.0Ah Li-ion 2 Adet

Hız - RPM / 0-1350 d/dk

Darbe Oranı: 0/4500 bpm

Darbe Gücü: 2.2 Joule

Aşırı Yük Korumalı

Titreşim Emici Kol

Ön Led Aydınlatma

Sağ ve Sol Vidalama

Koli: 2 Adet

**BRUSHLESS
MOTOR**

KÖMÜRSÜZ MOTOR

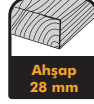
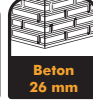
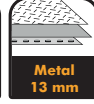
Ahşap
28 mmBeton
26 mmMetal
13 mm**2X** 20V 4.0Ah
BATARYA**100** 2.4A
Dakika Hızlı
Şarj

MODEL NO: DC2003



8 1684727 1930127

259 \$

Akülü Elektropnömatik Kırıcı Delici

DMX3013Sağ ve Sol
VidalamaTitreşim
Emici KolYumuşak
Kavrama

Impact Drill

3.8 Joule
DARBE GÜCÜ

4 Kademeli Hız Ayarı

Şarj Dolunca
Otomatik DurdurmaSDS
Plus

Batarya

20V 6.0Ah Li-ion 2 Adet

Hız - RPM / 0-1040 d/dk

Darbe Oranı: 0/4850 bpm

Darbe Gücü: 3.8 Joule

Aşırı Yük Korumalı

Titreşim Emici Kol

Ön Led Aydınlatma

Sağ ve Sol Vidalama

Koli: 2 Adet

**BRUSHLESS
MOTOR**

KÖMÜRSÜZ MOTOR

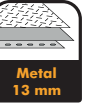
Ahşap
28 mmBeton
26 mmMetal
13 mm**2X** 20V 6.0Ah
BATARYA**150** 2.4A
Dakika Hızlı
Şarj

MODEL NO: DC2502



8 1684727 1930134

319 \$



Akülü Taşlama Makinesi

20V 4.0Ah LITHIUM-ION

DMX3014
**BRUSHLESS
MOTOR**
 KÖMÜRSÜZ MOTOR

 Kademeli
Hız Ayarı

 Titreşim
Emici Kol

 Yumuşak
Kavrama

100 2.4A Hızlı Şarj
 Dakika

 Şarj Dolunca
Otomatik Durdurma

115
 MM

125
 MM

Batarya

20V 4.0Ah Li-ion 2 Adet

Hız - RPM / 0-4000/6000/10000 d/dk

Disk Çapı / 115 mm - 125 mm

Aşırı Yük Korumalı

Titreşim Emici Kol

Ön Led Aydınlatma

Sağ ve Sol Vidalama

Koli: 4 Adet

 2X 20V 4.0Ah
 BATARYA

MODEL NO: A1620-125

207 \$

Akülü 4' lü Advantage Set

DMX3044

**BRUSHLESS
MOTOR**

KÖMÜRSÜZ MOTOR



Şarj Dolunca
Otomatik Durdurma



Kademeli
Hız Ayarı



Titreşim
Emici Kol



Yumuşak
Kavrama

115
MM

125
MM

2X 21V 4.0Ah
BATARYA

28 PARÇA AKSESUAR

**SDS
Plus**

60 2.4A
Dakika **Hızlı
Şarj**

273 \$

Koli: 2 Set



Kırıcı-Delici Matkap	Darbeli Matkap	Somun Sökme-Sıkma	Avuç Taşlama
Hız - RPM / 0-1350 d/dk	Hız - RPM / 0-450/2000 d/dk	Hız - RPM / 0-1000/1500/2150/2700 d/dk	Hız - RPM / 0-4000/6000/10000 d/dk
Darbe Oranı: 0/4500 lpm	Darbe Oranı: 0-5400/22500/3000 Bpm	Darbe Oranı: 0/1650/2500/3300/3900 lpm	Mak. Kesme Derinlik: 35 mm
Darbe Gücü: 2.8 Joule	Mandren Aralığı: 1.0-13 mm	Tork Gücü: 350Nm - 4 Kademeli	Disk Çapı: 115 mm - 125 mm
Aşırı Yük Korumalı	Tork Gücü: 45Nm	Mandren Aralığı: 1/2" - 12.7 mm	Aşırı Yük Korumalı
Titreşim Emici Kol	Aşırı Yük Korumalı	Aşırı Yük Korumalı	Titreşim Emici Kol
Ön Led Aydınlatma	Titreşim Emici Kol	Titreşim Emici Kol	Ön Led Aydınlatma
Sağ ve Sol Vidalama	Ön Led Aydınlatma	Ön Led Aydınlatma	Kademeli Hız
Mandren: Sds Plus	Sağ ve Sol Vidalama	Sağ ve Sol Çalışma	Titreşim Azaltıcı Sistem

DMAX AKILLI ŐARJ ÖZÜMÜ GÜÇLÜ VE KORUMALI

FAN
SOĐUTMALI
SİSTEM

AKILLI ŐARJ
CİHAZI

%100
TAM DOLUMDA

OTOMATİK
KAPANMA
ÖZELLİĐİ

GÜÇ
KESİLDİ



UZUN PİL
ÖMRÜ



GÜVENLİ
ŐARJ



YÜKSEK
VERİM

DMAX®

POWER and HAND TOOLS

**DMX3048****20V MAX**
2.0Ah
LITHIUM-ION

Batarya Güç Göstergeli

50 **2.4A** **Hızlı**
Dakika **Şarj**

8 684727 1930486



Koli: 20 Adet

34 \$

DMX3005-DMX3006-DMX3011 Kodlu Akülü Aletlerle Uyumludur.

DMX3049**20V MAX**
4.0Ah
LITHIUM-ION

Batarya Güç Göstergeli

100 **2.4A** **Hızlı**
Dakika **Şarj**

8 684727 1930493



Koli: 20 Adet

55 \$

DMX3007-DMX3008-DMX3009-DMX3012-DMX3014 Kodlu Akülü Aletlerle Uyumludur.

DMX3050**20V MAX**
6.0Ah
LITHIUM-ION

Batarya Güç Göstergeli

150 **2.4A** **Hızlı**
Dakika **Şarj**

8 684727 1930509



Koli: 20 Adet

74 \$

DMX3010-DMX3013 Kodlu Akülü Aletlerle Uyumludur.

DMX3051**12V MAX**
1.5Ah
LITHIUM-ION**90** **1.0A** **Hızlı**
Dakika **Şarj**

8 684727 1930516



Koli: 20 Adet

17 \$

DMX3004 Kodlu Akülü Aletle Uyumludur.

DMX3052**16V MAX**
2.0Ah
LITHIUM-ION**60** **2.0A** **Hızlı**
Dakika **Şarj**

8 684727 1930523



Koli: 20 Adet

23 \$

DMX3001-DMX3002-DMX3003 Kodlu Akülü Aletlerle Uyumludur.

DMX3054**Hızlı Şarj Ünitesi****13.5V MAX**
1.0Ah
LITHIUM-ION

8 684727 1930547



Koli: 20 Adet

10 \$

DMX3004 Kodlu Aküyü Şarj Eder.

DMX3055**Hızlı Şarj Ünitesi****16.8V MAX**
2.0Ah
LITHIUM-ION

8 684727 1930554



Koli: 20 Adet

17 \$

DMX3001-DMX3002-DMX3003 Kodlu Akülleri Şarj Eder.

DMX3053**Hızlı Şarj Ünitesi****21.5V MAX**
2.4Ah
LITHIUM-ION

8 684727 1930530



Koli: 20 Adet

16 \$DMX3000-DMX3005-DMX3006-DMX3007-DMX3008-DMX3009
DMX3010-DMX3011-DMX3012-DMX3013-DMX3014 Kodlu Akülleri Şarj Eder.



Darbesiz Matkap

DMX3040

500Watt

 Sağ ve Sol
Vidalama

 Titreşim
Emici Kol

 Yumuşak
Kavrama

 Kademeli
Hız Ayarı

 Tetik
Kilidi

 ANAHTARSIZ
PLASTİK MANDREN

Nominal Güç / 500 Watt

Hız: 0-2800 R/Min

Mandren Aralığı / 1.0-13 mm

Aşırı Yük Korumalı

Titreşim Emici Kol

Ahşap: 35 mm-Metal: 13 mm

Sağ ve Sol Vidalama

Koli: 10 Adet

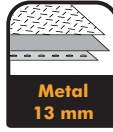
 Ahşap
35 mm

 Metal
13 mm

8 684 727 1930 400

41 \$

MODEL NO: J1ZE-KK82-10D 500

Darbeli Matkap

DMX3039

550Watt

 Sağ ve Sol
Vidalama

 Titreşim
Emici Kol

 Yumuşak
Kavrama

 Kademeli
Hız Ayarı

 Tetik
Kilidi

 Impact
Drill

 ANAHTARSIZ
PLASTİK MANDREN

Nominal Güç / 550 Watt

Hız: 0-2800 R/Min

Mandren Aralığı / 1.0-13 mm

Aşırı Yük Korumalı

Titreşim Emici Kol

Ahşap: 35 mm-Beton: 13 mm-Metal: 13 mm

Sağ ve Sol Vidalama

Koli: 10 Adet

 Ahşap
35 mm

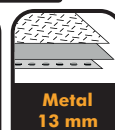
 Beton
13 mm

 Metal
13 mm

8 684 727 1930 394

44 \$

MODEL NO: Z1JE-KK82-13

Darbeli Matkap

DMX3038



710Watt



Sağ ve Sol Vidalama



Titreşim Emici Kol



Yumuşak Kavrama



Kademeli Hız Ayarı



Tetik Kilidi

Nominal Güç / 710 Watt

Hız: 0-2800 R/Min

Mandren Aralığı / 1.0-13 mm

Aşırı Yük Korumalı

Titreşim Emici Kol

Ahşap: 35 mm-Metal: 13 mm

Sağ ve Sol Vidalama

Koli: 10 Adet



Ahşap 35 mm



Beton 13 mm

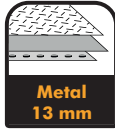

Metal 13 mm



ANAHTARSIZ PLASTİK MANDREN



Impact Drill

MODEL NO: Z1JE-KK75-13



8 684727 193038 7

51 \$

Alçıpan Vidalama Makinesi

DMX3034



**710Watt
18Nm**

Tork Gücü



Sağ ve Sol Vidalama



Titreşim Emici Kol



Yumuşak Kavrama



Kademeli Hız Ayarı



Tetik Kilidi



4mm-8mm Hex

Nominal Güç / 710 Watt

Hız: 0-4000 R/Min

Mandren Aralığı / 1.0-13 mm

Aşırı Yük Korumalı

Titreşim Emici Kol

Mak. Vidalama: 4 mm - 8 mm Hex

Mandren Giriş: 1/4 - 6.35 mm

Koli: 10 Adet

TİTREŞİM AZALTMA SİSTEM



VİDALAMA
OTOMATİK
DURDURMA
BİTİMİNDE

MODEL NO: P1U-DD-6



8 684727 193034 9

69 \$



Darbeli Somun Sıkma - Sökme Makinesi

DMX3035

1100Watt 450Nm

Tork Gücü

TİTREŞİM AZALTMA SİSTEM

**Sağ ve Sol
Çalışma**

**Titreşim
Emici Kol**

**Yumuşak
Kavrama**

**Kademeli
Hız Ayarı**

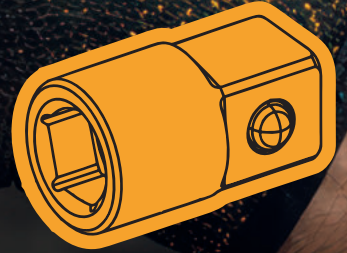
**Aşırı Yük
Koruma**

**LOKMA SETİ
HEDİYELİ
(17-19-21-22mm)**
Nominal Güç / 1100 Watt
Hız: 0-2200 R/Min
Tork Gücü: 450Nm
Mak. Somun Çapı: 22 mm
Mandren Giriş / 1/2" Kare Başlık
Aşırı Yük Korunmalı
Titreşim Emici Kol
Koli: 5 Adet

8 684 727 930 356

MODEL NO: P1B-DD16-12
127 \$

Elektro pnömatik Kırıcı ve Delici Matkap

DMX3046



SDS Plus



Sağ ve Sol Çalışma



Titreşim Emici Kol



Yumuşak Kavrama



Kademeli Hız Ayarı



Tetik Kilidi

Nominal Güç / 800 Watt

Hız: 0-1250 R/Min

Darbe Gücü: 3.0 Joule

Aşırı Yük Korumalı

Titreşim Emici Kol

Beton: 26 mm-Ahşap: 30 mm-Metal: 13 mm

5 Parça Matkap Uç Set

Koli: 5 Adet



800Watt
3.0Joule

Darbe Gücü

TITREŞİM AZALTMA SİSTEM



Impact Drill

MODEL NO: Z1A-HB-2601

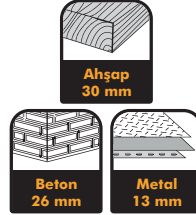

Ahşap
30 mm



Beton
26 mm

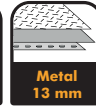

Metal
13 mm



8 6 8 4 7 2 7 1 9 3 0 4 6 2

88 \$

Elektro pnömatik Kırıcı ve Delici Matkap

DMX3047



SDS Plus



Sağ ve Sol Çalışma



Titreşim Emici Kol



Yumuşak Kavrama



Kademeli Hız Ayarı



Tetik Kilidi

Nominal Güç / 1100 Watt

Hız: 0-1300 R/Min

Darbe Gücü: 3.3 Joule

Aşırı Yük Korumalı

Titreşim Emici Kol

Beton: 32 mm-Ahşap: 30 mm-Metal: 13 mm

5 Parça Matkap Uç Set

Koli: 4 Adet



1100Watt
3.3Joule

Darbe Gücü

TITREŞİM AZALTMA SİSTEM



Impact Drill

MODEL NO: Z1A-HB-3436

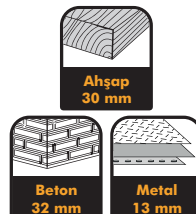

Ahşap
30 mm



Beton
32 mm

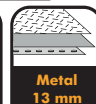

Metal
13 mm



8 6 8 4 7 2 7 1 9 3 0 4 7 9

105 \$



Avuç Taşlama Makinesi

DMX3022
115
MM
125
MM
750Watt

İki Taraflı Çalışma



Titreşim Emici Kol



Yumuşak Kavrama



Hızlı Soğuma

Nominal Güç / 750 Watt

Hız: 0-11000 R/Min

Disk Çapı: 115 mm - 125 mm

Mak. Kesme Derinliği: 35 mm

Hızlı Soğuma

Aşırı Yük Korumalı

Titreşim Emici Kol

Koli: 10 Adet

 1 Adet 115 mm
 Metal Kesme Diski
 Hediye

 ELEKTRİK KESİNTİSİ SONRASI
 GÜVENLİ BAŞLATMA

8 684 727 930 226

MODEL NO: 1082B-V2

47 \$

Avuç Taşlama Makinesi

DMX3023
115
MM
125
MM
750Watt

İki Taraflı Çalışma



Titreşim Emici Kol



Yumuşak Kavrama



Hızlı Soğuma

Nominal Güç / 750 Watt

Hız: 4500-11000 R/Min

Disk Çapı: 115 mm - 125 mm

Mak. Kesme Derinliği: 35 mm

Hızlı Soğuma

Aşırı Yük Korumalı

Titreşim Emici Kol

Koli: 10 Adet

 1 Adet 115 mm
 Metal Kesme Diski
 Hediye

DEVİR AYARLI



RESTART SAFETY

 ELEKTRİK KESİNTİSİ SONRASI
 GÜVENLİ BAŞLATMA

8 684 727 930 233

MODEL NO: 1082B-V2

54 \$

Avuç Taşlama Makinesi

DMX3024**115****MM****125****MM****950Watt**

İki Taraflı Çalışma



Titreşim Emici Kol



Yumuşak Kavrama



Hızlı Soğuma

Nominal Güç / 950 Watt

Hız: 0-11000 R/Min

Disk Çapı: 115 mm - 125 mm

Mak. Kesme Derinliği: 35 mm

Hızlı Soğuma

Aşırı Yük Korumalı

Titreşim Emici Kol

Koli: 10 Adet

1 Adet 115 mm
Metal Kesme Diski
HediyeELEKTRİK KESİNTİSİ SONRASI
GÜVENLİ BAŞLATMA

8 684 727 930240

MODEL NO: 1085B-V2

58 \$

Avuç Taşlama Makinesi

DMX3025**115****MM****125****MM****950Watt**

İki Taraflı Çalışma



Titreşim Emici Kol



Yumuşak Kavrama



Hızlı Soğuma

Nominal Güç / 950 Watt

Hız: 4500-11000 R/Min

Disk Çapı: 115 mm - 125 mm

Mak. Kesme Derinliği: 35 mm

Hızlı Soğuma

Aşırı Yük Korumalı

Titreşim Emici Kol

Koli: 10 Adet

1 Adet 115 mm
Metal Kesme Diski
Hediye

DEVİR AYARLI

ELEKTRİK KESİNTİSİ SONRASI
GÜVENLİ BAŞLATMA

8 684 727 930257

MODEL NO: 1085B-V2

63 \$



Avuç Taşlama Makinesi

DMX3026
115
MM
125
MM
1200Watt

İki Taraflı Çalışma



Titreşim Emici Kol



Yumuşak Kavrama



Hızlı Soğuma

Nominal Güç / 1200 Watt

Hız: 2800-11000 R/Min

Disk Çapı: 115 mm - 125 mm

Mak. Kesme Derinliği: 35 mm

Hızlı Soğuma

Aşırı Yük Korunmalı

Titreşim Emici Kol

Koli: 10 Adet

 1 Adet 115 mm
 Metal Kesme Diski
 Hediye

DEVİR AYARLI



RESTART SAFETY

 ELEKTRİK KESİNTİSİ SONRASI
 GÜVENLİ BAŞLATMA

8 684 727 930 264

MODEL NO: 1255L

78 \$

Polisaj Makinesi

DMX3017
1300Watt
180
MM

İki Taraflı Çalışma



Titreşim Emici Kol



Yumuşak Kavrama



Hızlı Soğuma

Nominal Güç / 1300 Watt

Hız: 800-3500 R/Min

Disk Çapı: 180 mm

Bağlantı Ucu: M14

Hızlı Soğuma

Aşırı Yük Korunmalı

Titreşim Emici Kol

Koli: 4 Adet

 1 Adet 180 mm
 Polisaj Padi
 Hediye

DEVİR AYARLI

360°
 Dönebilen
 Tutma Kolu

8 684 727 930 172

MODEL NO: LY190-01

101 \$

Büyük Taşlama Makinesi

DMX3015**RESTART SAFETY****ELEKTRİK KESİNTİSİ SONRASI
GÜVENLİ BAŞLATMA****180
MM****2200Watt****İki Taraflı Çalışma****Titreşim Emici Kol****Yumuşak Kavrama****Hızlı Soğuma****Nominal Güç / 2200 Watt****Hız: 8500 R/Min****Disk Çapı: 180 mm****Bağlantı Ucu: M14****Hızlı Soğuma****Aşırı Yük Korumalı****Titreşim Emici Kol****Koli: 2 Adet****360°
Dönebilen
Tutma Kolu****MODEL NO: LY-WS180****128 \$**

Büyük Taşlama Makinesi

DMX3016**RESTART SAFETY****ELEKTRİK KESİNTİSİ SONRASI
GÜVENLİ BAŞLATMA****230
MM****2200Watt****İki Taraflı Çalışma****Titreşim Emici Kol****Yumuşak Kavrama****Hızlı Soğuma****Nominal Güç / 2200 Watt****Hız: 6600 R/Min****Disk Çapı: 230 mm****Bağlantı Ucu: M14****Hızlı Soğuma****Aşırı Yük Korumalı****Titreşim Emici Kol****Koli: 2 Adet****1 Adet 115 mm
Metal Kesme Diski
Hediye****360°
Dönebilen
Tutma Kolu****MODEL NO: LY-WS230****130 \$**



Dekupaj Testere

DMX3037

 T144D Wood
 1 Adet Testere Bıçağı

450Watt



Hızlı Bıçak Değişimi



T ve U Bıçak



Aşırı Yük Koruması



45° Sağ-Sol Açılı Kesim

Nominal Güç / 450 Watt

Hız: 0-3000 R/Min

Bıçak Giriş Kılavuzu: T ve U

Bıçak İnme Mesafesi: 18 mm

Hızlı Soğuma

Aşırı Yük Korumalı

Koli: 10 Adet

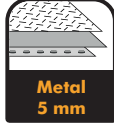
 Ahşap
60 mm

 Metal
5 mm

 Alüminyum
6 mm

 Plastik
6 mm

8 684 727 930370

MODEL NO: M1Q-DD3-55

TITREŞİM AZALTMA SİSTEMİ



40 \$

Dekupaj Testere

DMX3036

 T144D Wood
 1 Adet Testere Bıçağı

800Watt



Toz Emme Özelliği



Hızlı Bıçak Değişimi



T ve U Bıçak



Aşırı Yük Koruması



45° Sağ-Sol Açılı Kesim

Nominal Güç / 800 Watt

Hız: 0-3000 R/Min

Bıçak Giriş Kılavuzu: T ve U

Bıçak İnme Mesafesi: 22 mm

Hızlı Soğuma

Aşırı Yük Korumalı

Koli: 10 Adet

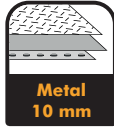
 Ahşap
100 mm

 Metal
10 mm

 Alüminyum
12 mm

 Plastik
12 mm

DEVİR AYARLI

TITREŞİM AZALTMA SİSTEMİ



8 684 727 930363

MODEL NO: M1Q-DD20-80



Ön Led Aydınlatma

Lazer Hizalama Çizgisi

72 \$

Tilki Kuyruğu Testere

DMX3033**750Watt**

Kademeli Hız



Hızlı Bıçak Değişimi



Yumuşak Kavrama



Aşırı Yük Koruması



180° Sağ-Sol Dönüş



Hızlı Bıçak Değişimi

Nominal Güç / 750 Watt

Hız: 0-2800 R/Min

Derinlik Hareketi: 20 mm

Anahtarsız Hızlı Bıçak Değişimi

Hızlı Soğuma

Aşırı Yük Korumalı

Koli: 6 Adet



TİTREŞİM ÖNLEYİCİ SİSTEM



1 Adet Metal Testere Bıçağı



8 684 727 930332

MODEL NO: M1W-DD18-115

66 \$

Ahşap 120 mm



Plastik 120 mm

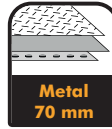

Metal 70 mm

Tilki Kuyruğu Testere

DMX3021**1200Watt**

Kademeli Hız



Hızlı Bıçak Değişimi



Yumuşak Kavrama



Aşırı Yük Koruması



180° Sağ-Sol Dönüş



Hızlı Bıçak Değişimi

Nominal Güç / 1200 Watt

Hız: 0-7000/13000 R/Min

Derinlik Hareketi: 28 mm

Anahtarsız Hızlı Bıçak Değişimi

Hızlı Soğuma

Aşırı Yük Korumalı

Ön Led Aydınlatma

Koli: 4 Adet



TİTREŞİM ÖNLEYİCİ SİSTEM



1 Adet Metal Testere Bıçağı



8 684 727 930219

MODEL NO: J1F-GW19-32

123 \$

Ahşap 250 mm



Plastik 250 mm



Metal 110 mm



Sunta Kesme Makinesi

DMX3018
1350Watt

 Mil
Kilidi

 Yumuşak
Kavrama

 Aşırı Yük
Koruması

 45° Sağ-Sol
Açılı Kesim

 Çift Emniyet
Şalteli

Nominal Güç / 1350 Watt

Hız: 5500 R/Min

Testere Çapı: 185 mm-40T

Mil Dişi: 20 mm

Aşırı Yük Korumalı

45° Açılı kesim Derinliği: 45 mm

0° Açılı Kesim Derinliği: 62 mm

Güvenlikli Tetik

Koli: 4 Adet

185
MM^{T40}

8 684727 930189

MODEL NO: M18501 (185mm)
90 \$

Profil Kesme Makinesi Profesyonel Tezgaah

DMX3041
2500Watt

 Mil
Kilidi

 Yumuşak
Kavrama

 Aşırı Yük
Koruması

 45° Sağ-Sol
Açılı Kesim

 Çelik
Taban

Nominal Güç / 2500 Watt

Hız: 3900 R/Min

Kıvılcım Saptırıcı Aparat

Kolay Kullanım, Mil Kilidi

Aşırı Yük Korumalı

Ağır Hizmet Tipi Çelik Taban

Kesme Derinliği: 120 mm

Koli: 1 Adet



8 684727 930417

MODEL NO: J1G-ZB-355B
251 \$

Sıcak Hava Tabancası Kademeli

DMX3031

Akıllı Termostat



Ekstra Kalın Teller



Aşırı Isı Koruması



Kademeli Isı Ayarı

2000Watt

Nominal Güç / 2000 Watt

Hava Akımı: 250/550 lt/dk

Aşırı Isı Korumalı

350° - 550° Sıcaklık Ayarlı

4 Farklı Nozul Uç

Koli: 10 Adet



8 684727 1930318

MODEL NO: JS-HG12 All

25 \$

Sıcak Hava Tabancası Dijital

DMX3032

Akıllı Termostat



Ekstra Kalın Teller



Aşırı Isı Koruması



Kademeli Isı Ayarı

2000Watt

Nominal Güç / 2000 Watt

Hava Akımı: 250/550 lt/dk

Aşırı Isı Korumalı

350° - 550° Sıcaklık Ayarlı

4 Farklı Nozul Uç

Koli: 5 Adet



8 684727 1930325

MODEL NO: JS-HG12D

70 \$



Boya Karıştırıcı

DMX3043
Mak. Uç
600 mmÇift Yönlü
ÇalışmaKarıştırıcı
120 mmKademeli
Hız AyarıTitreşim
Emici KolM14
Bağlantı

Nominal Güç / 1200 Watt

Hız: 4800 R/Min

Aşırı Isı Korumalı

Karıştırıcı Çapı: 120 mm

Max. Uç: 120x600 mm

Mil Dişi: M14

Koli: 4 Adet

1200Watt

8 684727 193043 1

MODEL NO: JL1636

82 \$

Boya ve Harç Karıştırıcı 2 Vitesli

DMX3027
Mak. Uç
600 mmÇift Yönlü
ÇalışmaKarıştırıcı
140 mmKademeli
Hız AyarıTitreşim
Emici KolM14
Bağlantı

Nominal Güç / 1800 Watt

Hız 1. Vites: 180-400 R/Min

Hız 2. Vites: 300-700 R/Min

Aşırı Isı Korumalı

Karıştırıcı Çapı: 140 mm

Max. Uç: 140x600 mm

Mil Dişi: M14

Koli: 2 Adet

1800Watt

8 684727 193027 1

MODEL NO: ST10-1800

129 \$

Titreşimli Zımpara Makinesi

DMX3020

Kademeli Hız



90/187mm Zımpara



Aşırı Yük Koruması



Yumuşak Kavrama



Pvc Toz Torbası



Orbital Salınım

Nominal Güç / 260 Watt

Hız: 0-7000/13000 R/Min

Zımpara Ölçüsü: 90 - 187 mm

Orbital Salınım: 2 mm

Taban Cinsi: Cırtlı Metal

Aşırı Yük Korumalı

Titreşim Emici Kol

Koli: 6 Adet

TITREŞİM AZALTICI İZOLASYON

**260Watt**

MODEL NO: S1B-GW3 90X187

1 Adet
Cırtlı Zımpara

8 684727 193020 2

67 \$

Eksantrik Zımpara Makinesi

DMX3019

DEVİR AYARLI



125/150mm Zımpara



Aşırı Yük Koruması



Yumuşak Kavrama



Pvc Toz Torbası



Orbital Salınım

Nominal Güç / 450 Watt

Hız: 0-7000/13000 R/Min

Zımpara Ölçüsü: 125 - 150 mm

Orbital Salınım: 2 mm

Taban Cinsi: Cırtlı Metal

Aşırı Yük Korumalı

Titreşim Emici Kol

Koli: 4 Adet

TITREŞİM AZALTICI İZOLASYON

Dünyada İlk
125 mm ve 150 mm
Uyumlu
Zımpara Tabanı

2 Adet

Cırtlı Zımpara

450Watt

MODEL NO: S1A-GW4-125



8 684727 193019 6

71 \$

Alçıpan Duvar Zımpara Makinesi

DMX3028

750Watt

TITREŞİM AZALTMA SİSTEM



360°
Led Işıklı

Otomatik
Toz Vakum
Torbalı



Kademeli
Hız



Titreşim
Emici Kol



Yumuşak
Kavrama



Zımpara
225 mm



Aşırı Yük
Koruma



Çelik
Taban



Elektrik Süpürgesi
Gerektirmeyen
Toz Vakum Sistemi



6X Cırtlı
225 mm Zımpara

Nominal Güç / 750 Watt

Hız: 1000/1850 R/Min

Zımpara Tabanı: 225 mm

Zımpara Taban Hava Emişi: 10 Delikli

Ayarlı 160 cm Kol - Oynar Başlıklı

Aşırı Yük Korumalı

Otomatik Toz Emiş Sistemi

Koli: 2 Adet



MODEL NO: DMJ-700C-6GT

213 \$

Hava Üfleme ve Vakumlama Makinesi

DMX3030



600Watt



Üfleme Vakumlama



Aşırı Yük Koruması



Yumuşak Kavrama



Üfleme Hızı 3.2³/min



Tetik Kilidi



Kademeli Hız

Nominal Güç / 600 Watt

Hız: 0-16000 ml/dk

Üfleme Hızı: 3.2 m³/min

Üfleme-Vakumlama

Tetik Sabitleme

Aşırı Yük Korumalı

Tezgahestü Sabit Mod

Koli: 6 Adet

MODEL NO: JS-EB15B



8 684 727 930 301

49 \$

Elektrikli Boya Püskürtme Tabancası

DMX3029



950Watt



AÇI AYARLI



1200 ml/Dk



1.5/2.5mm Nodü Ölçüsü



Aşırı Yük Koruması



1300 ml

Nominal Güç / 950 Watt

Hız: 1200 ml/dk

Mak. Akışkanlık: 120 DIN/sn

Boya Haznesi: 1300 ml

Nozul Ölçüsü: 1.5 / 2.5 mm Bakır

Aşırı Yük Korumalı

Koli: 4 Adet

MODEL NO: JS-ASP950



8 684 727 930 295

91 \$

Tezgah Üstü Testere Makinesi Ayaklı

1800Watt

DMX3042

Genişleyen
Tabla

Yükseklik
Ayarlı
Ayaklar



Çelik
Taban



Testere Çap
255 mm



Genişleyen
Tabla



Zımpara
225 mm



Aşırı Yük
Koruma

Nominal Güç / 1800 Watt

Hız: 4300 R/Min

Testere Çapı: 255 mm

Masa Ölçüsü Kapalı: 583x563 mm

Masa Ölçüsü Açık: 583x893 mm

Aşırı Yük Korunmalı

90°'den 45°'ye Kadar Açılı Kesim

Koli: 1 Adet



8 684 727 930 424

MODEL NO: M1YD-ZB-2541A

334 \$

Yetkili Satış Noktası Olun. Raflarınızda Fark Yararın!



DMAX®
POWER and HAND TOOLS

**Güçlü
Çözümler!**



Ayrıntılı Bilgi





TR DMAX®

POWER and HAND TOOLS

ZOR ŞARTLARDA, MAKSİMUM PERFORMANS

TR DMAX®

POWER and HAND TOOLS

YERLİ
—ve—
MİLLİ

PROFESYONEL ŞERİT METRE



GÜÇLÜ
GÖVDE



KONFORLU
KULLANIM



HASSAS
ÖLÇÜM



Dayanıklı



ABS



Oto Kilit



CALIBRATION

İşlerinizin Çözüm Ortağı...

Çağrı
Merkezi 0 8 5 0
840 92 34

 Güncel Fiyatlar için
 Okutunuz

Profesyonel Çelik Şerit Metre

KOD : DMX4745

ÜRÜN : 3 mt x 16 mm

PAKET : Kutu: 12 Adet / Koli: 144 Adet



Profesyonel Çelik Şerit Metre

KOD : DMX4746

ÜRÜN : 5 mt x 19 mm

PAKET : Kutu: 12 Adet / Koli: 120 Adet



Profesyonel Çelik Şerit Metre

KOD : DMX4747

ÜRÜN : 5mt x 25 mm

PAKET : Kutu: 12 Adet / Koli: 96 Adet



Profesyonel Çelik Şerit Metre

KOD : DMX4748

ÜRÜN : 10mt x 25 mm

PAKET : Kutu: 12 Adet / Koli: 48 Adet



TR DMAX®

POWER and HAND TOOLS

YERLİ VE MİLLİ
PROFESYONELLERE ÖZEL SERİ

www.dmaxtools.com

YERLİ
—ve—
MİLLİ



 Güncel Fiyatlar için
 Okutunuz

Metal Maket Bıçağı Sarı-Siyah

KOD : DMX4808

ÜRÜN : Metal Maket Bıçağı Sarı

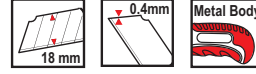
PAKET : 24 Adet Stand / 288 Adet Koli



BARKOD



8 695 442 1948083

Koli: 25 kg - 470x320x505mm

Metal Maket Bıçağı Kırmızı-Siyah

KOD : DMX4809

ÜRÜN : Metal Maket Bıçağı Kırmızı

PAKET : 24 Adet Stand / 288 Adet Koli

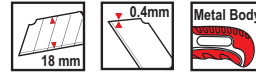

BARKOD



8 695 442 1948090

Koli: 25 kg - 470x320x505mm



Güncel Fiyatlar için
Okutunuz

Metal Maket Bıçağı Kırmızı

KOD : DMX1712

ÜRÜN : Profesyonel Metal Maket Bıçağı Kırmızı

PAKET : 24 Adet Stand / 192 Adet Koli

Koli: 20 kg - 380x370x355mm

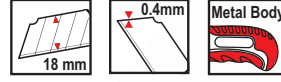

BARKOD



8 695 442 1947901

Metal Maket Bıçağı Kırmızı

KOD : DMX4743

ÜRÜN : Eko Metal Maket Bıçağı Kırmızı

PAKET : 24 Adet Stand / 288 Adet Koli

Koli: 25 kg - 380x370x355mm

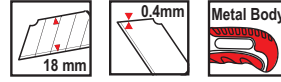

BARKOD



8 695 442 1943187

Metal Maket Bıçağı Dar

KOD : DMX4744

ÜRÜN : Profesyonel Metal Maket Bıçağı Dar

PAKET : 50 Adet Stand / 800 Adet Koli

Koli: 25 kg - 380x370x355mm

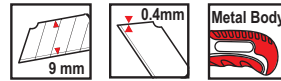

BARKOD



8 695 442 1943187

YERLİ
—ve—
MILLİ

 Güncel Fiyatlar için
 Okutunuz



Plastik Maket Bıçağı Siyah

KOD : DMX1713

ÜRÜN : Eko Plastik Maket Bıçağı Siyah

PAKET : 24 Adet Stand / 288 Adet Koli

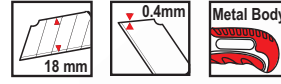
Koli: 21 kg - 380x370x355mm



BARKOD



8 695 442 194 79 18

Plastik Maket Bıçağı Sarı

KOD : DMX1820

ÜRÜN : Pro Plastik Maket Bıçağı Sarı

PAKET : 24 Adet Stand / 192 Adet Koli

Koli: 14 kg - 380x370x355mm

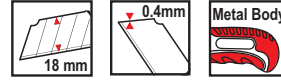

BARKOD



8 695 442 194 84 34

Plastik Maket Bıçağı Kırmızı

KOD : DMX1819

ÜRÜN : Pro Plastik Maket Bıçağı Kırmızı

PAKET : 24 Adet Stand / 192 Adet Koli

Koli: 25 kg - 380x370x355mm

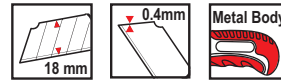

BARKOD



8 695 442 194 84 34

YERLİ
 —ve—
MILLİ



Güncel Fiyatlar için
Okutunuz



Bagaj Lastiği Yassı 100 cm



KOD : DMX4751

ÜRÜN : Bagaj Lastiği Yassı 100 cm

PAKET : 300 Adet



Bagaj Lastiği Standart 0.70 mm x 100 cm

KOD : DMX7316

ÜRÜN : Bagaj Lastiği Standart 0.70 mm x 100 cm

PAKET : 500 Adet



Bagaj Lastiği Standart 0.90 mm x 100 cm

KOD : DMX7318

ÜRÜN : Bagaj Lastiği Standart 0.90 mm x 100 cm

PAKET : 300 Adet



YERLİ
—ve—
MİLLİ



TR **DMAX**[®]

POWER and HAND TOOLS

MATKAP UÇLARI, KIRICI UÇLAR VE KESİCİLER



Sds Plus Hilti Ucu

110 mm

Kod	Açıklama	Kutu Adet	Koli Adet	Fiyat
DMX4693	5x110 mm	40	480	0,73 \$
DMX4466	6x110 mm	40	480	0,76 \$
DMX4467	7x110 mm	40	480	0,79 \$
DMX4468	8x110 mm	40	480	0,82 \$
DMX4469	9x110 mm	30	360	0,82 \$
DMX4470	10x110 mm	30	360	0,88 \$
DMX4471	11x110 mm	30	360	0,94 \$
DMX4472	12x110 mm	30	360	0,97 \$

160 mm

Kod	Açıklama	Kutu Adet	Koli Adet	Fiyat
DMX4674	5x160 mm	40	400	0,89 \$
DMX4446	6x160 mm	40	400	0,90 \$
DMX4447	7x160 mm	40	400	1,06 \$
DMX4448	8x160 mm	30	300	1,12 \$
DMX4449	9x160 mm	30	300	1,24 \$
DMX4450	10x160 mm	30	300	1,28 \$
DMX4451	11x160 mm	25	250	1,36 \$
DMX4452	12x160 mm	25	250	1,42 \$
DMX4453	13x160 mm	20	200	1,81 \$
DMX4454	14x160 mm	20	200	2,08 \$
DMX4455	15x160 mm	20	200	2,20 \$

210 mm

Kod	Açıklama	Kutu Adet	Koli Adet	Fiyat
DMX4695	5x210 mm	30	300	1,14 \$
DMX4434	6x210 mm	30	300	1,19 \$
DMX4435	7x210 mm	30	300	1,24 \$
DMX4436	8x210 mm	30	300	1,24 \$
DMX4437	9x210 mm	25	250	1,40 \$
DMX4438	10x210 mm	25	250	1,46 \$
DMX4439	11x210 mm	20	200	1,54 \$
DMX4440	12x210 mm	20	200	1,62 \$
DMX4441	13x210 mm	15	150	2,07 \$
DMX4442	14x210 mm	15	150	2,34 \$
DMX4443	15x210 mm	15	150	2,52 \$
DMX4444	16x210 mm	15	150	2,73 \$
DMX4445	18x210 mm	10	100	3,39 \$

350 mm

Kod	Açıklama	Kutu Adet	Koli Adet	Fiyat
DMX4473	8x350 mm	80	160	2,04 \$
DMX4474	10x350 mm	60	120	2,16 \$
DMX4475	12x350 mm	50	100	2,27 \$
DMX4476	14x350 mm	40	80	3,12 \$
DMX4477	16x350 mm	40	80	4,27 \$
DMX4478	18x350 mm	25	50	4,65 \$
DMX4479	20x350 mm	25	50	5,62 \$
DMX4480	22x350 mm	20	40	6,52 \$
DMX4481	24x350 mm	20	40	8,14 \$

450 mm

Kod	Açıklama	Kutu Adet	Koli Adet	Fiyat
DMX4482	10x450 mm	50	100	2,67 \$
DMX4483	12x450 mm	50	100	2,85 \$
DMX4484	14x450 mm	40	80	3,79 \$
DMX4485	16x450 mm	25	50	4,40 \$
DMX4486	18x450 mm	20	40	5,54 \$
DMX4487	20x450 mm	15	30	6,84 \$
DMX4488	22x450 mm	15	30	7,88 \$
DMX4489	24x450 mm	12	24	9,79 \$
DMX4490	26x450 mm	12	24	11,15 \$
DMX4696	28x450 mm	12	24	13,81 \$

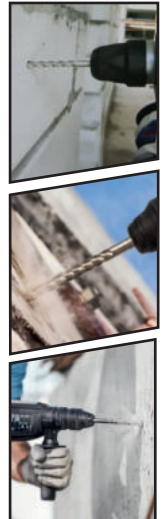
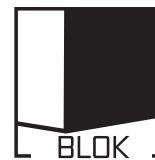
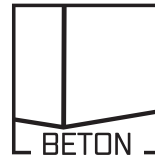
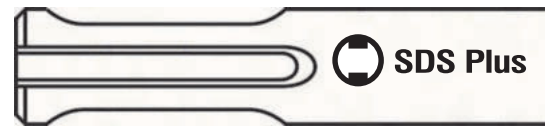



Sds Plus Keski



- ▶ Tavlanmış Yüksek Çelik Kalitesi
- ▶ Güçlü Kazıma ve Kırma
- ▶ Her Türlü Taş, Beton, Granit, Seramik, Asfalt, Mermer



Kod	Açıklama	Kutu Adet	Koli Adet	Fiyat
DMX4491	14x250x22 mm	10	80	1,57 \$

Sds Plus Murç



- ▶ Tavlanmış Yüksek Çelik Kalitesi
- ▶ Güçlü Kazıma ve Kırma
- ▶ Her Türlü Taş, Beton, Granit, Seramik, Asfalt, Mermer



Kod	Açıklama	Kutu Adet	Koli Adet	Fiyat
DMX4493	14x250 mm	10	80	1,51 \$

Sds Plus Geniş Keski

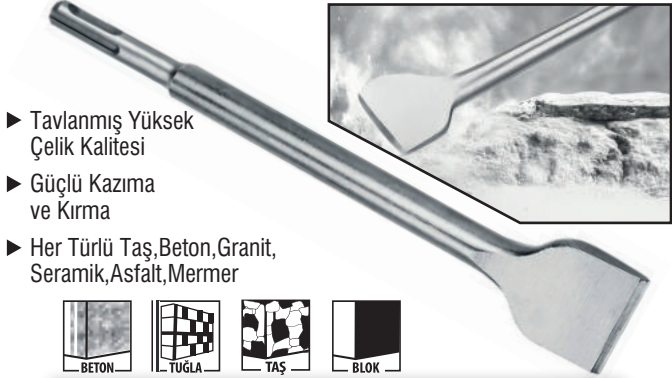

- ▶ Tavlanmış Yüksek Çelik Kalitesi
- ▶ Güçlü Kazıma ve Kırma
- ▶ Her Türlü Taş, Beton, Granit, Seramik, Asfalt, Mermer



Kod	Açıklama	Kutu Adet	Koli Adet	Fiyat
DMX4492	14x250x40 mm	10	80	2,14 \$

Sds Plus Oluklu Keski

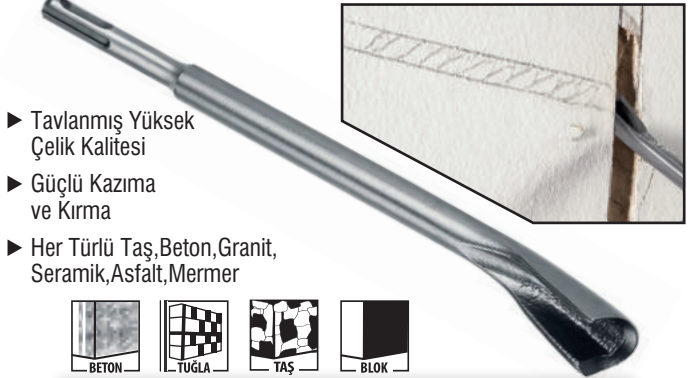

- ▶ Tavlanmış Yüksek Çelik Kalitesi
- ▶ Güçlü Kazıma ve Kırma
- ▶ Her Türlü Taş, Beton, Granit, Seramik, Asfalt, Mermer



Kod	Açıklama	Kutu Adet	Koli Adet	Fiyat
DMX4494	14x250 mm	10	80	2,18 \$

Sds Max Murç / Keski

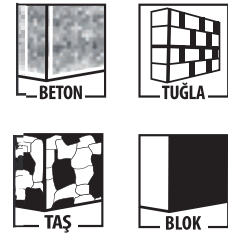
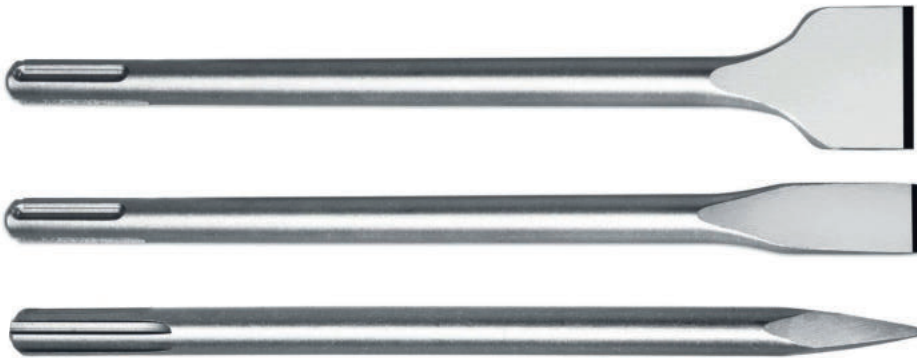

- ▶ Tavlanmış Yüksek Çelik Kalitesi
- ▶ Güçlü Kazıma ve Kırma
- ▶ Her Türlü Taş, Beton, Granit, Seramik, Asfalt, Mermer

Sds Max Geniş Keski

Kod	Açıklama	Kutu Adet	Koli Adet	Fiyat
DMX4499	18x400x50 mm	10	20	5,01 \$

Sds Max Keski

Kod	Açıklama	Kutu Adet	Koli Adet	Fiyat
DMX4495	18x400x25 mm	12	24	4,02 \$
DMX4496	18x600x25 mm	8	16	5,99 \$

Sds Max Murç

Kod	Açıklama	Kutu Adet	Koli Adet	Fiyat
DMX4497	18x400 mm	12	24	4,04 \$
DMX4498	18x600 mm	8	16	5,99 \$

Panç Seti



6
PARÇA
BUAT

38-54mm
3/8
Hex ve
Anahtar



► Yüksek Karbonlu Çelik ► Isıl İşlem Uygulanmış Dişler

Kod	Açıklama	Kutu Adet	Koli Adet	Fiyat
DMX4127	6 Parça	25	100	2,37 \$
DMX4124	8 Parça	1	30	5,45 \$
DMX4125	11 Parça	1	40	4,31 \$
DMX4126	16 Parça	1	30	8,35 \$

Bi Metal Panç Takımı



► Yüksek Karbonlu Çelik ► Isıl İşlem Uygulanmış Dişler

Kod	Açıklama	Kutu Adet	Koli Adet	Fiyat
DMX4502	9 Pcs/19-57mm	1	10	33,16 \$
DMX4503	13 Pcs/19-64mm	1	5	50,43 \$

Panç Seti 7 Parça



YENİ ÜRÜN

Ø 26mm
Ø 32-38mm
Ø 45-50mm
Ø 56-63mm

Blisterli Ambalaj

Kod	Açıklama	Kutu Adet	Koli Adet	Fiyat
DMX4714	7 Parça	30	60	2,77 \$

Çok Amaçlı Ayarlı Delme Seti Panç



Ürün Tanıtım
Ø 50 mm - 130 mm

Blisterli Ambalaj



Pvc - Ahşap - Suntalam - Alçıpan

Kod	Açıklama	Kutu Adet	Koli Adet	Fiyat
DMX4763	3 Bıçaklı	8	32	14,55

Sds Bi Metal Panç Adaptörü

Blisterli Ambalaj



SDS

► Güçlü Gövde Matkap Kullanımı için

Kod	Açıklama	Kutu Adet	Koli Adet	Fiyat
DMX4132	14-29mm	10	200	2,01 \$
DMX4133	30-210mm	10	100	3,50 \$

Hex Bi Metal Panç Adaptörü

Blisterli Ambalaj



HEX

► Güçlü Gövde Matkap Kullanımı için

Kod	Açıklama	Kutu Adet	Koli Adet	Fiyat
DMX4130	14-29mm	10	200	1,41 \$
DMX4131	30-210mm	10	100	3,32 \$

Ayarlı Delme Panç Seti



M2 CUTTER BLADES

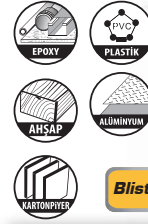

Blisterli Ambalaj

MAX 200 RPM

Kod	Açıklama	Kutu Adet	Koli Adet	Fiyat
DMX4393	40-200mm	5	50	6,27 \$
DMX4394	40-300mm	5	50	7,54 \$



Sds Beton Buat Açma Adaptörü



► Beton buat açma aparatını matkaplarda kullanımını sağlayan adaptör



Kod	Açıklama	Kutu Adet	Koli Adet	Fiyat
DMX4353	250 mm	15	30	4,73 \$
DMX4354	400 mm	10	20	6,68 \$

Sds Max Buat Açma Adaptörü



► Beton buat açma aparatını matkaplarda kullanımını sağlayan adaptör



Kod	Açıklama	Kutu Adet	Koli Adet	Fiyat
DMX4352	400 mm	10	20	7,09 \$

Sds Beton Buat Açma Seti

Blisterli Ambalaj

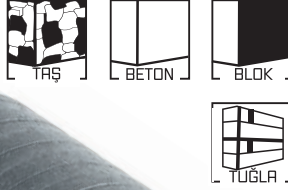

► Kesici Elmas Dişler
► Beton, Gaz Beton, Taş Tuğla ve Benzeri Malzemeyi Güvenli ve Hızlı delme imkanı verir.



Kod	Açıklama	Kutu Adet	Koli Adet	Fiyat
DMX4504	30 mm	5	20	6,18 \$
DMX4505	35 mm	5	20	6,65 \$
DMX4506	40 mm	5	20	7,32 \$
DMX4507	45 mm	5	20	7,64 \$
DMX4508	50 mm	5	20	8,28 \$
DMX4509	55 mm	5	20	8,59 \$
DMX4510	60 mm	5	20	9,23 \$
DMX4511	65 mm	5	20	9,87 \$
DMX4512	70 mm	5	20	10,66 \$
DMX4513	75 mm	5	20	11,62 \$
DMX4514	80 mm	5	20	12,25 \$
DMX4515	100 mm	4	8	16,55 \$
DMX4516	110 mm	4	8	18,14 \$
DMX4517	120 mm	4	8	22,02 \$

Mermer Granit Delme Pauç



Kod	Açıklama	Kutu Adet	Koli Adet	Fiyat
DMX4370	16 mm	10	100	5,41 \$
DMX4371	18 mm	10	100	6,11 \$
DMX4372	20 mm	10	100	6,81 \$
DMX4373	25 mm	10	100	8,47 \$
DMX4374	30 mm	10	100	10,19 \$
DMX4375	33 mm	10	100	10,95 \$
DMX4376	35 mm	10	100	11,78 \$
DMX4713	40 mm	6	72	13,53 \$



Hss Matkap Ucu Siyah / Beyaz



HSS
DIN 338

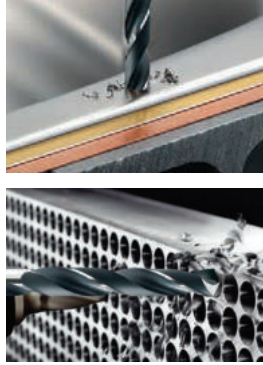

- Haddeli Yüksek Çelik Kalitesi
- Silindirik Saplı
- Spiral Yüzey

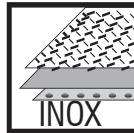
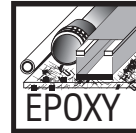

Kod	Açıklama	Kutu Adet	Koli Adet	Fiyat
DMX4416	2 mm	250	10000	0,10 \$
DMX4417	2,5 mm	250	5000	0,10 \$
DMX4418	3 mm	250	5000	0,10 \$
DMX4419	3,5 mm	250	5000	0,12 \$
DMX4420	4 mm	250	3000	0,13 \$
DMX4421	4,5 mm	250	3000	0,15 \$
DMX4422	5 mm	100	2000	0,19 \$
DMX4423	5,5 mm	100	2000	0,24 \$
DMX4424	6 mm	100	2000	0,28 \$
DMX4425	6,5 mm	100	2000	0,32 \$
DMX4426	7 mm	100	1000	0,40 \$
DMX4427	7,5 mm	100	1000	0,45 \$
DMX4428	8 mm	50	1000	0,55 \$
DMX4429	8,5 mm	25	500	0,58 \$
DMX4430	9 mm	25	500	0,65 \$
DMX4431	10 mm	25	500	0,93 \$
DMX4432	11 mm	25	300	1,18 \$
DMX4433	12 mm	25	300	1,45 \$

Elmas Matkap Ucu

- Spiral Yüzey
- Tavlanmış Yüksek Çelik Kalitesi
- Kesici Elmas Uç

Kod	Açıklama	Kutu Adet	Koli Adet	Fiyat
DMX4567	5x85 mm	60	1200	0,46 \$
DMX4568	6x100 mm	50	1000	0,56 \$
DMX4569	7x100 mm	40	800	0,65 \$
DMX4570	8x120 mm	30	600	0,81 \$
DMX4571	9x120 mm	20	400	1,48 \$
DMX4572	10x120 mm	20	400	1,78 \$
DMX4573	11x150 mm	15	300	1,84 \$
DMX4574	12x150 mm	12	240	2,01 \$

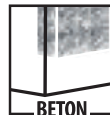



Kademeli Matkap Ucu

HSS
 TITANIUM
 COATED

Kod	Açıklama	Kutu Adet	Koli Adet	Fiyat
DMX4355	4-12 mm	20	120	2,15 \$
DMX4356	4-20 mm	20	120	3,16 \$
DMX4359	4-39 mm	25	50	10,91 \$
DMX4360	6-52 mm	18	36	18,55 \$

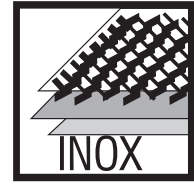
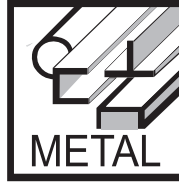

Blisterli Kademeli Matkap Uç Seti 3 Parça

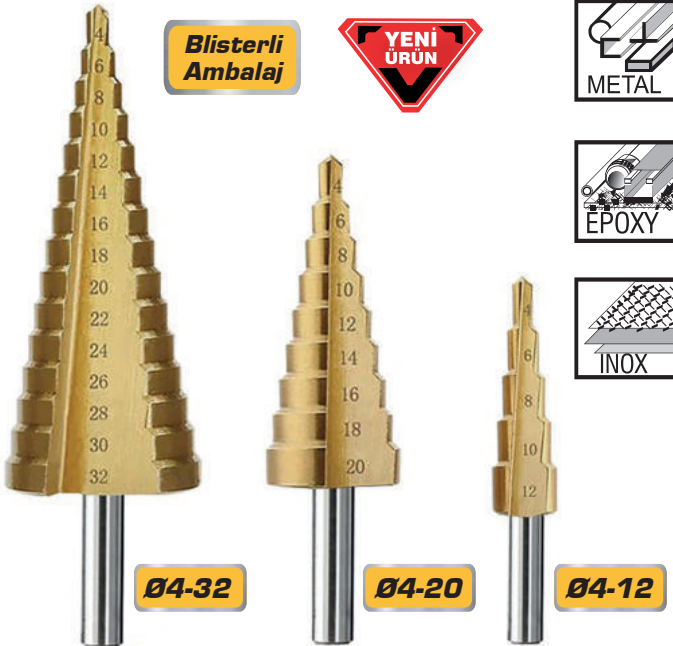

Kod	Açıklama	Kutu Adet	Koli Adet	Fiyat
DMX2291	Blisterli/3 Pcs	25	50	5,86 \$

Blisterli Kademeli Matkap Ucu



Kod	Açıklama	Kutu Adet	Koli Adet	Fiyat
OZS-2292	4x12 mm	50	200	1,41 \$
OZS-2293	4x20 mm	25	100	1,92 \$

Sds Ahşap Matkap Ucu

SDS Ahşap Matkap Ucu 250 mm

Kod	Açıklama	Kutu Adet	Koli Adet	Fiyat
DMX4519	8x250 mm	100	200	1,39 \$
DMX4520	10x250 mm	100	200	1,51 \$
DMX4521	12x250 mm	100	200	1,75 \$
DMX4522	14x250 mm	80	160	2,14 \$
DMX4523	16x250 mm	80	160	2,58 \$
DMX4524	18x250 mm	50	100	3,02 \$
DMX4525	20x250 mm	50	100	3,99 \$
DMX4526	22x250 mm	50	100	4,59 \$
DMX4527	24x250 mm	50	100	5,31 \$

SDS Plus

- ▶ Tavlanmış Yüksek Çelik Kalitesi
- ▶ Sertleştirilmiş Kesme Kenarları
- ▶ Talaş Tahliyesi Ekstra Derin Oluklar
- ▶ Spiral Merkez Nokta

SDS Ahşap Matkap Ucu 500 mm

Kod	Açıklama	Kutu Adet	Koli Adet	Fiyat
DMX4528	8x500 mm	50	100	2,34 \$
DMX4529	10x500 mm	50	100	2,58 \$
DMX4530	12x500 mm	50	100	2,94 \$
DMX4531	14x500 mm	40	80	3,88 \$
DMX4532	16x500 mm	30	60	4,49 \$
DMX4533	18x500 mm	30	60	5,16 \$
DMX4534	20x500 mm	30	60	6,36 \$
DMX4535	22x500 mm	20	40	8,04 \$
DMX4536	24x500 mm	20	40	9,30 \$

Sds Kalıpçı Ahşap Matkap Ucu

- ▶ Tavlanmış Yüksek Çelik Kalitesi



SDS Kalıpçı Ahşap Matkap Ucu 600 mm

Kod	Açıklama	Kutu Adet	Koli Adet	Fiyat
DMX4537	10x600 mm	25	50	4,23 \$
DMX4538	12x600 mm	25	50	4,71 \$
DMX4539	14x600 mm	25	50	5,27 \$
DMX4540	16x600 mm	25	50	5,50 \$
DMX4541	18x600 mm	20	40	5,78 \$
DMX4542	20x600 mm	20	40	6,31 \$
DMX4708	22x600 mm	20	40	7,07 \$
DMX4709	24x600 mm	20	40	8,88 \$



Cam Seramik Delme Matkap Ucu

- Cam, Fayans, Seramik, Tuğla, Kompozit, Alüminyum.
- Çok amaçlı universal matkap ucu.

Blisterli Ambalaj

Ürün Tanıtım



Kod	Açıklama	Kutu Adet	Koli Adet	Fiyat
DMX4341	6 mm	30	300	2,89 \$
DMX4342	7 mm	30	300	3,59 \$
DMX4343	8 mm	30	300	3,69 \$
DMX4344	10 mm	30	300	3,84 \$

Ahşap Freze Bıçağı

- Tüm kompozit malzemeleri
- Kontraplak, sert ağaç
- Katı yüzey ve yumuşak yüzey ahşaplarda kullanıma uygundur.

Çap delikleri, açılı delikler, üstüste binme delikleri ve düz alt delikler için kullanılır.



Kod	Açıklama	Kutu Adet	Koli Adet	Fiyat
DMX4339	35mmx70mm	12	240	3,19 \$

Havşa Matkap Ucu

- Silindirik Sap
- Ayarlanabilir Uzunluk
- Kesici Bıçak

Blisterli Ambalaj

Kod	Açıklama	Kutu Adet	Koli Adet	Fiyat
DMX4336	3 mm	25	300	1,94 \$
DMX4337	3,5 mm	25	300	1,94 \$
DMX4338	4 mm	25	300	1,94 \$

Çok Amaçlı Matkap Ucu Delme Diş Açma 6 Parça



Ürün Tanıtım

Blisterli Ambalaj

Set İçi Ölçüleri

3
4
5
6
8
10

Metal - Çelik - Plastik - Ahşap - Alüminyum

Kod	Açıklama	Kutu Adet	Koli Adet	Fiyat
DMX4764	6 Parça	20	120	8,19 \$

Beton Matkap Uç Seti 8 Parça



Set içi Ölçüleri

3x75
4x75
5x85
6x100
7x100
8x120
9x120
10x75



Kod	Açıklama	Kutu Adet	Koli Adet	Fiyat
DMX4348	8 Parça	12	96	5,57 \$

Ahşap Matkap Uç Seti 8 Pcs



Set içi Ölçüleri

3mm
4mm
5mm
6mm
7mm
8mm
9mm
10mm



▶ Sertleştirilmiş kesme kenarlar
▶ Talas tahliesi derin oluklar

Kod	Açıklama	Kutu Adet	Koli Adet	Fiyat
DMX4347	8 Parça	12	120	2,80 \$

Ahşap Beton Metal Matkap Uç Seti 16 Parça



Set içi Ölçüler

Metal	Beton Uç	Ahşap Uç
2mm	4x75	4mm
3mm	5x85	5mm
4mm	6x100	6mm
5mm	8x120	8mm
6mm	10x120	10mm
8mm		



Kod	Açıklama	Kutu Adet	Koli Adet	Fiyat
DMX4345	16 Parça	12	72	8,53 \$

HSS Matkap Uç Seti 13 Parça



Set içi Ölçüler

1.5mm 4mm
2mm 4.5mm
2.5mm 4.8mm
3mm 5mm
3.2mm 5.5mm
3.5mm 6mm
6.5mm



Kod	Açıklama	Kutu Adet	Koli Adet	Fiyat
DMX4346	13 Parça	12	120	2,90 \$

Ahşap Beton Metal Matkap Uç Seti 9 Parça



Set içi Ölçüler

Metal	Beton Uç	Ahşap Uç
5mm	5x85	5mm
6mm	6x100	6mm
8mm	8x120	8mm



Kod	Açıklama	Kutu Adet	Koli Adet	Fiyat
OZS-9007	9 Parça	50	100	3,55 \$

Matkap Uç ve Dübel Seti



Set içi Ölçüler

7 Adet Metal Matkap Ucu: 2,3,4,5,7,8,10mm ◀
5 Adet Beton Matkap Ucu: 4,5,6,8,10mm ◀
5 Adet Ahşap Matkap Ucu: 4,5,6,8,10mm ◀
6 Adet Bits Uç: 5,6,PH1,2,PZ1,2 ◀
1 Adet Bits Uç Tutucu ◀
5,6,8,10 mm Dübel ◀



Kod	Açıklama	Kutu Adet	Koli Adet	Fiyat
OZS-8511	Ahşap-HSS-Beton	10	20	8,05 \$



Çok Amaçlı Matkap Uç Seti 5 Parça



Set İçi Ölçüleri

6mm

7mm

8mm

10mm

12mm

- **Beton:** Duvar delme işlemleri.
- **Seramik:** Fayans, mermer gibi sert yüzeylerde delik açma.
- **Ahşap:** Tahta ve mobilya montajlarında.
- **Metal:** Hafif ve orta sertlikte metallerin delinmesi.
- **Plastik:** Plastik yüzeylerde temiz ve düzgün delikler açmak için.

► Çok amaçlı kullanıma uygun olması sayesinde tek bir set ile bir çok farklı yüzeyi delme imkanı sağlar



Ürün Tanıtım

Kod	Açıklama	Kutu Adet	Koli Adet	Fiyat
DMX4721	5 Parça	10	100	11,59 \$

Freze Matkap Uç Seti 3 Parça



Set İçi Ölçüleri

4mm

6mm

8mm

- **Ahşap:** Mobilya yapımı, oyma ve kanal açma işlemleri
- **Metal:** İnce metal yüzeylerde kanal açma ve şekillendirme
- **Plastik:** Plastik yüzeylerde delme ve şekillendirme
- **Ahşap Oymacılığı, Plastik İşçiliği ve ince metal işlerinde kullanıma uygundur.**

► Çok amaçlı kullanıma uygun olması sayesinde tek bir set ile bir çok farklı yüzeyi delme ve oyma imkanı sağlar



Ürün Tanıtım

Kod	Açıklama	Kutu Adet	Koli Adet	Fiyat
DMX4690	3 Parça	12	144	2,70 \$

Metal Mandren Supra Kilitli

Güçlü Silindirik Alanı
**10 mm 3/8
13 mm 1/2**
Otomatik Kilit Sistemi

Kod	Açıklama	Kutu Adet	Koli Adet	Fiyat
DMX4501	3/8 10 mm	1	100	7,24 \$
DMX4500	1/2 13mm	1	50	9,15 \$

Plastik Mandren

Otomatik Kilit Sistemi

Kod	Açıklama	Kutu Adet	Koli Adet	Fiyat
DMX4122	13 mm 1/2	1	60	3,96 \$

Metal Mandren Anahtarlı

Blisterli Ambalaj

Kod	Açıklama	Kutu Adet	Koli Adet	Fiyat
DMX4120	13mm - 1/2	6	60	3,71 \$

Anahtarlı Ve Adaptörlü Mandren Seti 3 Pcs

Blisterli Ambalaj

Kod	Açıklama	Kutu Adet	Koli Adet	Fiyat
DMX4121	13mm - 1/2	6	60	4,17 \$

Mandren Anahtarı

Blisterli Ambalaj

Kod	Açıklama	Kutu Adet	Koli Adet	Fiyat
DMX4128	10-13 mm	100	400	0,56 \$

Yıldız Uçlu Bits PH2



Kod	Açıklama	Kutu Adet	Koli Adet	Fiyat
DMX4040	PH2x25 mm	10	2400	0,14 \$
DMX4041	PH2x50 mm	10	1200	0,28 \$
DMX4042	PH2x75 mm	10	800	0,34 \$

Pozidriv Uçlu Bits PZ2



Kod	Açıklama	Kutu Adet	Koli Adet	Fiyat
DMX4045	PZ2x25 mm	10	2400	0,14 \$
DMX4046	PZ2x50 mm	10	1200	0,28 \$
DMX4047	PZ2x75 mm	10	800	0,34 \$
DMX4048	PZ2x100 mm	10	600	0,51 \$
DMX4049	PZ2x150 mm	10	400	0,74 \$

Torx Uçlu Bits T30



Kod	Açıklama	Kutu Adet	Koli Adet	Fiyat
DMX4051	T30x75 mm	10	800	0,34 \$
DMX4052	T30x100 mm	10	600	0,51 \$
DMX4053	T30x150 mm	10	400	0,74 \$

Düz Uçlu Bits SL



Kod	Açıklama	Kutu Adet	Koli Adet	Fiyat
DMX4054	SL5.5x50 mm	10	1200	0,28 \$

Stoplu Bits Uç PH2



Kod	Açıklama	Kutu Adet	Koli Adet	Fiyat
DMX2299	PH2x25 mm	20	2000	0,24 \$



Mıknatıs Uçlu Bits Uç Çift Yönlü



Kod	Açıklama	Kutu Adet	Koli Adet	Fiyat
DMX4563	PH2x65 mm	10	1200	0,61 \$
DMX4564	PZ2x65 mm	10	1200	0,61 \$

Mıknatıs Uçlu Bits Uç



Kod	Açıklama	Kutu Adet	Koli Adet	Fiyat
DMX4565	PH2x65 mm	10	1200	0,61 \$
DMX4566	PZ2x65 mm	10	1200	0,61 \$

Titanyum Kaplı Spiral Bits Uç Seti



Ürün Tanıtım

YENİ ÜRÜN

Blisterli Set

PH2x50mm

1 Adet

PH2x65mm

2 Adet

PH2x90mm

3 Adet



Kod	Açıklama	Kutu Adet	Koli Adet	Fiyat
DMX4769	6 Parça Set	10	120	3,82 \$

Manyetik Somun Adaptörü

- Chrome Vanadium Çeliği
- Sert, Güçlü ve Hassas

CR-V
 HRC:50-52°

Magnetized Tip



Kod	Açıklama	Kutu Adet	Koli Adet	Fiyat
DMX4331	8 x 45 mm	12	480	0,31 \$
DMX4332	10 x 45 mm	10	400	0,35 \$
DMX4333	11 x 45 mm	8	320	0,44 \$
DMX4334	12 x 45 mm	6	240	0,45 \$
DMX4335	13 x 48 mm	5	200	0,48 \$

Manyetik Somun Adaptörü Seti 9 Parça

Set içi Ölçüler

5mm

6mm

7mm

8mm

9mm

10mm

11mm

12mm

13mm



Magnetized Tip



Blisterli Ambalaj



Kod	Açıklama	Kutu Adet	Koli Adet	Fiyat
DMX4070	9 Parça	12	144	2,22 \$

Bits Uç Uzatma Adaptörü

- Sert, Güçlü ve Hassas



Kod	Açıklama	Kutu Adet	Koli Adet	Fiyat
DMX4350	10x60 mm	10	800	0,37 \$

Speed Manyetik Uç Tutucu

YENİ ÜRÜN



Ürün Tanıtım



Blisterli Ambalaj

Kod	Açıklama	Kutu Adet	Koli Adet	Fiyat
DMX4765	Ayarlı	20	120	3,19 \$

Hex Plus Lokma Adaptör Seti 3 Parça



Blisterli Set

Set içi Ölçüleri

1/4 50mm

3/8 65mm

1/2 73mm



Kod	Açıklama	Kutu Adet	Koli Adet	Fiyat
DMX4712	3 Parça Set	25	100	2,29 \$

Hex Plus Lokma Adaptör Seti 2 Parça



1/4 50 mm

1/2 73 mm

Blisterli Ambalaj

Kod	Açıklama	Kutu Adet	Koli Adet	Fiyat
DMX4766	2 Parça	25	100	1,88 \$

Bits ve Adaptör Seti 16 Parça



Blisterli Ambalaj

Set içi Ölçüler

1/2 x 70mm Hex Somun Adaptörü

3/8 x 65mm Hex Somun Adaptörü

1/4 x 65mm Hex Somun Adaptörü

1/4 x 60mm Adaptör

1/4 x 100mm Adaptör

1/4 x 150mm Adaptör

10 Adet Bits Uç Seti

Kod	Açıklama	Kutu Adet	Koli Adet	Fiyat
OZS-1887	16 Parça	12	72	5,04 \$

Esnek Bits Uç Uzatma Set

► Matkapın veya tomavıdanın sığmadığı dar ve karmaşık bölgelerde delme ve vidalama imkanı sağlar



► Esnek Tasarım
► Manyetik Uç Tutucu
► Dayanıklılık Malzeme

Blisterli Ambalaj

Kod	Açıklama	Kutu Adet	Koli Adet	Fiyat
DMX4073	12 Parça	16	96	2,36 \$

Vidalama Köşe Adaptörü 60 mm



Ürün Tanıtım



► Matkap veya Tomavıdanın Sığmadığı Bölgelerde Delme ve Vidalama İşlemini Mümkün Kılar



Blisterli Ambalaj



Kod	Açıklama	Kutu Adet	Koli Adet	Fiyat
DMX4768	60 mm	25	200	2,46 \$

Vidalama Köşe Adaptörü 140 mm



Ürün Tanıtım

► Matkap veya Tomavıdanın Sığmadığı Bölgelerde Delme ve Vidalama İşlemini Mümkün Kılar



Blisterli Ambalaj



Kod	Açıklama	Kutu Adet	Koli Adet	Fiyat
DMX4543	140 mm	50	100	4,45 \$



Profesyonel Ultra Hassas Seramik Kesme Testere

- Seramik, Granit, Porselen ve Mermer
- Çapaksız Hassas Kesim
- Sulu Kesim

1.2 mm
Kalınlık
ULTRA
İNCE

Kod	Açıklama	Kutu Adet	Koli Adet	Fiyat
DMX4402	115x1.2x22-23mm	12	192	6,28 \$
DMX4403	180x1.6x22-23mm	12	72	11,06 \$

Hassas Seramik Kesme Testeresi

- Seramik, Granit, Porselen ve Mermer
- Sulu ve Kuru Kesim

1.3 mm
Kalınlık

YENİ ÜRÜN

Kod	Açıklama	Kutu Adet	Koli Adet	Fiyat
DMX4710	115x1.3x22-23	12	192	5,47 \$

Soketli Elmas Testere

- Isınma ve Aşınmayı Önleyen Soketli Elmas Testere
- Seramik, Granit, Beton, Taş, Mermer
- Kuru Kesim



Kod	Açıklama	Kutu Adet	Koli Adet	Fiyat
DMX4400	115 mm	20	200	2,49 \$
DMX4401	180 mm	10	100	4,95 \$

Turbo Elmas Testere

- Isınma ve Aşınmayı Önleyen Soketli Elmas Testere
- Seramik, Granit, Beton, Taş, Mermer
- Kuru Kesim



Kod	Açıklama	Kutu Adet	Koli Adet	Fiyat
DMX4398	115 mm	20	200	2,49 \$
DMX4399	180 mm	10	100	4,95 \$

Zincirli Ahşap Testere

- Odun ve ağaç kesimi
- Ahşap, Mdf ve Sunta lam Kesimi
- Mobilya ve Marangozluk işleri
- Atölye ve Hobi Çalışmaları

115 mm **22-23 mm**

Ürün Tanıtım

Kod	Açıklama	Kutu Adet	Koli Adet	Fiyat
DMX4397	115 mm	25	100	5,00 \$

Ahşap Eğe Disk

- Oyma ve Kesim: Ahşap üzerinde dekoratif oyma ve detaylı kesim imkanı sağlar
- Ahşap İşleme: Yüzey temizleme, şekillendirme ve kaba tesviye işlemlerinde kullanılır.
- Mobilya ve Marangozluk işleri: Zımpara ve yüzey düzeltme işlemlerinde kullanıma uygundur

Blisterli Ambalaj

Blisterli Ambalaj

Kod	Açıklama	Kutu Adet	Koli Adet	Fiyat
DMX4518	115x22mm	6	72	4,42 \$

Ahşap Eğe Disk Düz

- Oyma ve Kesim: Ahşap üzerinde dekoratif oyma ve detaylı kesim imkanı sağlar
- Ahşap İşleme: Yüzey temizleme, şekillendirme ve kaba tesviye işlemlerinde kullanılır.
- Mobilya ve Marangozluk işleri: Zımpara ve yüzey düzeltme işlemlerinde kullanıma uygundur

Blisterli Ambalaj

YENİ ÜRÜN

Ürün Tanıtım

Kod	Açıklama	Kutu Adet	Koli Adet	Fiyat
DMX4759	115x22mm	6	72	3,79 \$

Çok Amaçlı Metal Kesme Diski

- ▶ Metal Kesim: Çelik, demir gibi metal malzemelerin hassas ve düzgün şekilde kesimi için uygundur
- ▶ Mermer İşleme: Mermer yüzeylerin kesimi ve şekillendirilmesinde kullanıma uygundur
- ▶ Cam Kesimi: Hassas cam kesim işlemleri için uygundur
- ▶ Hobi ve Diy Projeleri: Evde yada atölyede amatör projelerde çok yönlü kesim işlemleri için uygundur



Ürün Tanıtım

Kod	Açıklama	Kutu Adet	Koli Adet	Fiyat
DMX4720	115x1.3x22-23	10	200	4,65 \$



Ahşap ve Pvc Kesme Diski



- ▶ Ahşap Kesimi
- ▶ Pvc Kesimi
- ▶ Alüminyum Kesimi
- ▶ Surtalam Kesimi



Ürün Tanıtım



Kod	Açıklama	Kutu Adet	Koli Adet	Fiyat
DMX4719	115mm x 22-23mm	10	200	3,55 \$

Cam Seramik Hassas Kesme Diski



- ▶ Cam Kesimi
- ▶ Porselen Kesimi
- ▶ Seramik Kesimi



Ürün Tanıtım



Kod	Açıklama	Kutu Adet	Koli Adet	Fiyat
DMX4676	115mmx1.0mm-22-23mm	10	200	3,47 \$

Elmas Taşlama Silme Diski

- ▶ Beton, Mermer, Granit, Doğal Taş ve Kuvars



Kod	Açıklama	Kutu Adet	Koli Adet	Fiyat
DMX4396	115 mm 22-23	6	48	5,66 \$
DMX4711	180 mm 22-23	4	24	14,13 \$

Metal Plaka ve Sac Kesme Aparatı

- ▶ Metal Plaka Kesimi
- ▶ Sanayi ve Atölyeler
- ▶ Hobi ve el işleri
- ▶ Otomotiv ve İnşaat
- ▶ Metal plakaların ve sac malzemelerinin kolay, hızlı ve hassas işlenmesine yardımcı olur.



Ürün Tanıtım



Blisterli Ambalaj

Kod	Açıklama	Kutu Adet	Koli Adet	Fiyat
DMX4689	Metal ve Sac	1	50	10,50 \$



Inox Kesici Taş



- Hızlı ve Kolay Kesim
- Yüksek Kalite Hassas Çalışma



Kod	Açıklama	Kutu Adet	Koli Adet	Fiyat
DMX4391	115mm x 1.0mm	50	500	0,36 \$
DMX4404	180mm x 1.6mm	25	200	0,90 \$

Metal Kesici Taş

- Hızlı ve Kolay Kesimi
- Yüksek Kalite Hassas Çalışma



Kod	Açıklama	Kutu Adet	Koli Adet	Fiyat
DMX4405	115mm x 2,5mm	50	200	0,47 \$
DMX4406	180mm x 3mm	25	100	1,12 \$

Çapak Alma Taşı

- Hızlı ve Kolay Kesimi
- Yüksek Kalite Hassas Çalışma



Kod	Açıklama	Kutu Adet	Koli Adet	Fiyat
DMX4407	115mm x 6.0mm	25	200	0,81 \$

Flap Disk Alüminyum Oxide

- Çelik ve metallerin taşlanması ve yüzeylerin temizlenmesi için kullanılır



Kod	Açıklama	Kutu Adet	Koli Adet	Fiyat
DMX4000	115x40 Kum	20	200	0,66 \$
DMX4001	115x60 Kum	20	200	0,66 \$
DMX4002	115x80 Kum	20	200	0,66 \$
DMX4003	115x100 Kum	20	200	0,66 \$
DMX4004	115x120 Kum	20	200	0,66 \$
DMX4005	180x60 Kum	10	100	1,76 \$

Flap Disk Zirkonyum



Kod	Açıklama	Kutu Adet	Koli Adet	Fiyat
DMX4006	115x40 Kum	20	200	0,98 \$
DMX4007	115x60 Kum	20	200	0,98 \$
DMX4008	115x80 Kum	20	200	0,98 \$

Pasta Polisaj Süngeri

150 MM

M14



Kod	Açıklama	Kutu Adet	Koli Adet	Fiyat
DMX4030	M14 150 mm	75	150	2,39 \$

Pasta Polisaj Süngeri Cırtlı Ped

150 MM

M14



Kod	Açıklama	Kutu Adet	Koli Adet	Fiyat
DMX4031	150 mm Düz Ped	125	250	1,19 \$
DMX4032	150 mm Yumurta Ped	125	250	1,19 \$

Cırtlı Disk Zımpara Tabanı

- ▶ M-14 Makine Bağlantı Somunu
- ▶ Uygulanan Yüzeğe Göre Esneyen Yumuşak Ped
- ▶ Zımpara Takılan Cırtlı Yüzeğe



M14

Kod	Açıklama	Kutu Adet	Koli Adet	Fiyat
DMX4021	115 mm	50	200	0,92 \$
DMX4022	180 mm	25	100	1,83 \$

Cırtlı Disk Zımpara Seti 6 Parça 115-180 mm



M14

Set içi Ölçüler

40 KUM

60 KUM

80 KUM

Kod	Açıklama	Kutu Adet	Koli Adet	Fiyat
DMX4009	115 mm	50	200	1,29 \$
DMX4010	180 mm	25	100	3,06 \$

Su Zımparası



Kod	Açıklama	Kutu Adet	Koli Adet	Fiyat
DMX4023	P60 Kum	100	1000	0,11 \$
DMX4024	P80 Kum	100	1000	0,11 \$
DMX4025	P100 Kum	100	1000	0,11 \$
DMX4026	P120 Kum	100	1000	0,11 \$
DMX4027	P150 Kum	100	1000	0,11 \$
DMX4028	P180 Kum	100	1000	0,11 \$
DMX4029	P220 Kum	100	1000	0,11 \$

Cırtlı Zımpara Padi Delikli

225 MM



Elektrikli ve Akülü Duvar Zımpara Makinaları için uygundur.

Kod	Açıklama	Kutu Adet	Koli Adet	Fiyat
DMX4703	225mm x 100P	100	800	0,27 \$
DMX4704	225mm x 120P	100	800	0,27 \$
DMX4705	225mm x 150P	100	800	0,27 \$
DMX4706	225mm x 180P	100	800	0,27 \$
DMX4707	225mm x 220P	100	800	0,27 \$



Cırtlı Zımpara Padi 115 mm

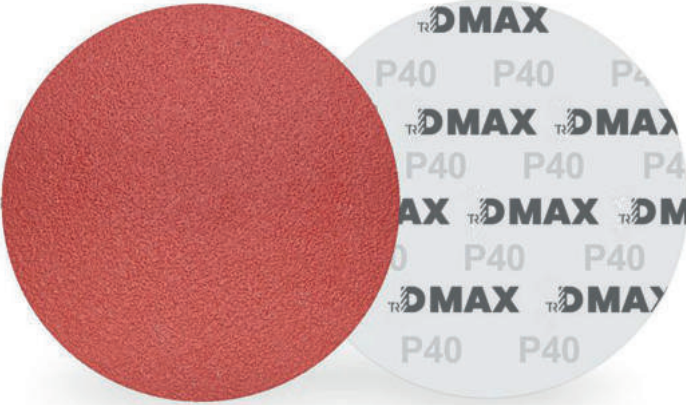

115 MM

- Ahşap, Plastik, Metal Malzemelerde Yüksek Talaş Kaldırma ve Yüzey Polijajına Uygun Kolay çalışma Sağlar

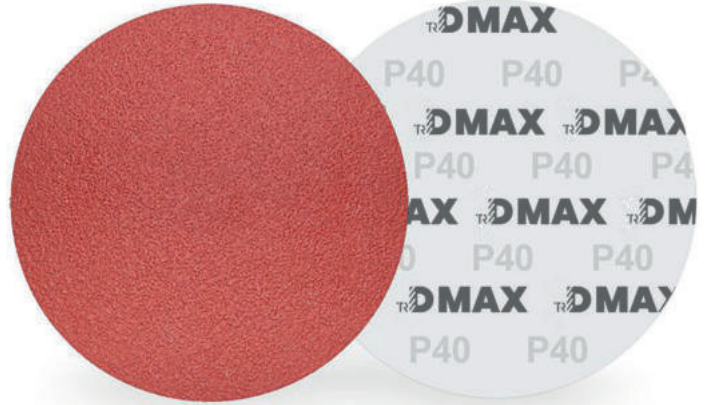

Kod	Açıklama	Kutu Adet	Koli Adet	Fiyat
DMX4011	40 Kum	100	3000	0,08 \$
DMX4012	60 Kum	100	3000	0,08 \$
DMX4013	80 Kum	100	3000	0,08 \$
DMX4014	100 Kum	100	3000	0,08 \$
DMX4015	120 Kum	100	3000	0,08 \$

Cırtlı Zımpara Padi 180 mm

180 MM

- Ahşap, Plastik, Metal Malzemelerde Yüksek Talaş Kaldırma ve Yüzey Polijajına Uygun Kolay çalışma Sağlar



Kod	Açıklama	Kutu Adet	Koli Adet	Fiyat
DMX4016	40 Kum	100	1000	0,19 \$
DMX4017	60 Kum	100	1000	0,19 \$
DMX4018	80 Kum	100	1000	0,19 \$
DMX4019	100 Kum	100	1000	0,19 \$
DMX4020	120 Kum	100	1000	0,19 \$

Tırpan Taşı Oval

9" INCH

- Kullanım Alanları: Makas Bıçak çakı v.b. Kesicilerin bilenmesinde kullanılır.

Kod	Açıklama	Kutu Adet	Koli Adet	Fiyat
DMX4074	No: 9	1	100	0,81 \$

Bileme Taşı

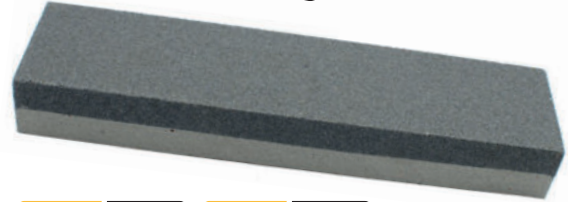
150 MM 200 MM

Kod	Açıklama	Kutu Adet	Koli Adet	Fiyat
DMX4076	150 mm	1	50	1,28 \$
DMX4077	200 mm	1	50	1,42 \$

Pro Kırmızı Tırpan Taşı Oval

9" INCH

- Kullanım Alanları: Makas Bıçak çakı v.b. Kesicilerin bilenmesinde kullanılır.

Kod	Açıklama	Kutu Adet	Koli Adet	Fiyat
DMX4075	No: 9	1	100	1,22 \$



Şişe Kriko

- Kompakt Yapı
- Kolay Kullanım ve Onarım
- Hidrolik Mekanizma
- Paslanmaz Gövde



**Ultra
Güç**

Kod	Açıklama	Kutu Adet	Koli Adet	Fiyat
DMX4099	2 Ton	1	10	17,15 \$
DMX4100	3 Ton	1	8	21,10 \$
DMX4101	5 Ton	1	6	26,00 \$
DMX4102	10 Ton	1	4	34,99 \$



Manuel Kollu Kriko

2 TON

- Kolay Kullanım ve Onarım
- Paslanmaz Gövde
- Kompakt Yapı



Kod	Açıklama	Kutu Adet	Koli Adet	Fiyat
DMX4105	2 Ton	1	10	18,97 \$

Cırcır Kollu Kriko

- Kolay Kullanım ve Onarım
- Paslanmaz Gövde
- Kompakt Yapı



Kod	Açıklama	Kutu Adet	Koli Adet	Fiyat
DMX4103	1,5 Ton	1	10	22,88 \$
DMX4104	2 Ton	1	10	24,67 \$

Tekerlekli Kriko

- Kompakt Yapı
- Kolay Kullanım ve Onarım
- Hidrolik Mekanizma
- Paslanmaz Gövde
- Ayarlanabilir Basınç



Kod	Açıklama	Kutu Adet	Koli Adet	Fiyat
DMX4199	2 Ton	1	4	46,01 \$

2 TON



Min. Yükseklik: 125 mm
Max. Yükseklik: 300 mm



Çanak Fırça Saçaklı

- Yüzey Temizleyici
- Pas Sökücü
- Boya Sökücü
- Pirinç Kaplı Çelik Tel



Kod	Açıklama	Kutu Adet	Koli Adet	Fiyat
DMX4036	65 mm	50	100	1,08 \$
DMX4037	75 mm	50	100	1,15 \$
DMX4038	100 mm	30	60	1,85 \$

Çanak Fırça Burgulu

- Yüzey Temizleyici
- Pas Sökücü
- Boya Sökücü
- Burgulu Çelik Tel



Kod	Açıklama	Kutu Adet	Koli Adet	Fiyat
DMX4033	65 mm	50	100	1,43 \$
DMX4034	75 mm	50	100	1,46 \$
DMX4035	100 mm	30	60	2,09 \$

Saçaklı Dairesel Fırça

- Yüzey Temizleyici
- Pas Sökücü
- Boya Sökücü
- Pirinç Kaplı Çelik Tel



Kod	Açıklama	Kutu Adet	Koli Adet	Fiyat
DMX4078	150 mm	20	40	4,31 \$
DMX4079	175 mm	15	30	4,52 \$
DMX4080	200 mm	10	20	5,40 \$

Pimli Çanak Fırça

- Yüzey Temizleyici
- Pas Sökücü
- Boya Sökücü
- Pirinç Kaplı Çelik Tel



Kod	Açıklama	Kutu Adet	Koli Adet	Fiyat
DMX4082	65 mm	20	240	1,01 \$

Pimli Daire Fırça

- Yüzey Temizleyici
- Pirinç Kaplı Çelik Tel
- Boya Sökücü
- Pas Sökücü



Kod	Açıklama	Kutu Adet	Koli Adet	Fiyat
DMX4081	75 mm	20	240	0,74 \$

Pimli Kalem Fırça

- Yüzey Temizleyici
- Pas Sökücü
- Boya Sökücü
- Pirinç Kaplı Çelik Tel



Kod	Açıklama	Kutu Adet	Koli Adet	Fiyat
DMX4083	25 mm	40	400	0,59 \$

Saçaklı Tel Fırça Seti 5 Parça

Blisterli Ambalaj

Set içi Ölçüler

50mm Pimli Daire

65mm Pimli Daire

25mm Pimli Kalem

50mm Pimli Çanak

65mm Pimli Çanak



Kod	Açıklama	Kutu Adet	Koli Adet	Fiyat
DMX4085	5 Parça	15	60	3,59 \$

Saçaklı Tel Fırça Seti 3 Parça

Blisterli Ambalaj

Set içi Ölçüler

65mm Pimli Daire

25mm Pimli Kalem

65mm Pimli Çanak



Kod	Açıklama	Kutu Adet	Koli Adet	Fiyat
DMX4084	3 Parça	40	120	2,16 \$

Çelik Yassı Tel Fırça

250 MM

- YüzeY Temizleyici
- Pirinç Kaplı Çelik Tel
- Boya Sökücü
- Pas Sökücü



► Dar Açılı Bölgeler, Köşeler ve Borular Gibi Ulaşılması Zor Yerlerde Temizleme için İdealdir

Kod	Açıklama	Kutu Adet	Koli Adet	Fiyat
DMX4088	250 mm	12	144	0,76 \$

Profesyonel Tel Fırça Seti 3 Parça



Blisterli Ambalaj

9 INCH

Kod	Açıklama	Kutu Adet	Koli Adet	Fiyat
DMX4129	7 Inch - 3 Parça	24	96	2,84 \$

Ahşap Saplı Tel Fırça

- Dar Açılı Bölgeler, Köşeler ve Borular Gibi Ulaşılması Zor Yerlerde Temizleme için İdealdir

Blisterli Ambalaj

8 INCH



Kod	Açıklama	Kutu Adet	Koli Adet	Fiyat
DMX4247	8 Inch	12	360	0,56 \$

Mini Tel Fırça Seti 3 Parça

- Dar Açılı Bölgeler, Köşeler ve Borular Gibi Ulaşılması Zor Yerlerde Temizleme için İdealdir

Blisterli Ambalaj

7 INCH



Kod	Açıklama	Kutu Adet	Koli Adet	Fiyat
DMX4087	3 Parça	30	240	0,65 \$

Plastik Saplı Tel Fırça Seti 2 Parça

- Dar Açılı Bölgeler, Köşeler ve Borular Gibi Ulaşılması Zor Yerlerde Temizleme için İdealdir

Blisterli Ambalaj

9 INCH



Kod	Açıklama	Kutu Adet	Koli Adet	Fiyat
DMX4086	2 Parça	12	120	1,24 \$



Çok Amaçlı Fırça Seti 3 Parça

Blisterli Ambalaj



3 Parça



Kod	Açıklama	Kutu Adet	Koli Adet	Fiyat
DMX4729	3 Parça Set	1	42	4,51 \$

Çok Amaçlı Tel Fırça Seti 3 Parça



Blisterli Ambalaj

8 INCH



Pirinç Kaplı Tel Fırça



Yüksek Dayanıklılık



Ergonomik Tutuş

Kod	Açıklama	Kutu Adet	Koli Adet	Fiyat
DMX4681	8 Inch	12	120	2,55 \$

Kestirme Fırça Seti 2 Parça



No 2

No 2,5

Kod	Açıklama	Kutu Adet	Koli Adet	Fiyat
OZS-8147	2 Parça Set	60	240	1,54 \$

Kestirme Fırça Seti 3 Parça



No 1,5

No 1

No 2

Kod	Açıklama	Kutu Adet	Koli Adet	Fiyat
OZS-8149	3 Parça Set	60	240	1,57 \$

Kestirme Fırça ve Spatula Seti 3 Parça

50mm
Spatula

No 1,5

No 1

Kod	Açıklama	Kutu Adet	Koli Adet	Fiyat
OZS-8148	3 Parça Set	60	240	1,57 \$

Ahşap Saplı Sıva Malası

- Ahşap sap, doğal ve ergonomik tutuş sağlar.
- Uygulama sırasında elin kaymasını engeller.
- Dayanıklı çelik gövde, uzun ömürlü kullanım sunar.

Konforlu
Tutuş

Kod	Açıklama	Kutu Adet	Koli Adet	Fiyat
DMX4770	18 cm	12	72	2,04 \$
DMX4771	20 cm	12	72	2,15 \$
DMX4772	22 cm	12	72	2,19 \$
DMX4773	24 cm	12	48	2,33 \$

Fiber Saplı Spatula

Konforlu
Tutuş

Kod	Açıklama	Kutu Adet	Koli Adet	Fiyat
DMX4781	40 mm	12	240	0,79 \$
DMX4190	50 mm	12	240	0,84 \$
DMX4191	60 mm	12	240	0,88 \$
DMX4192	80 mm	12	240	0,95 \$
DMX4193	100 mm	12	240	1,01 \$
DMX4722	125 mm	12	240	1,08 \$
DMX4723	150 mm	12	240	1,20 \$

Profesyonel Su Terazisi Miknatıslı



- Dayanıklı Alüminyum kutu profili gövde
- Ultrasonik Kaynaklama yoluyla monte edilmiş 2 Akrilik gösterge
- Mükemmel Hassasiyet 0.5mm/m
- Köşeleri yuvarlatılmış göstergelerle Hassas ölçüm
- Darbe emici Lastik Profil sonu başlıkları
- Büyüteçli Göstergeler ile kolay okuma

Best Star

Kod	Açıklama	Kutu Adet	Koli Adet	Fiyat
DMX4060	40 cm	10	60	8,57 \$
DMX4061	50 cm	10	60	9,56 \$
DMX4062	60 cm	10	60	10,22 \$
DMX4063	80 cm	10	40	12,59 \$
DMX4064	100 cm	10	30	14,73 \$

Profesyonel Su Terazisi



- Dayanıklı Alüminyum kutu profili gövde
- Ultrasonik Kaynaklama yoluyla monte edilmiş 2 Akrilik gösterge
- Mükemmel Hassasiyet 0.5mm/m
- Köşeleri yuvarlatılmış göstergelerle Hassas ölçüm
- Darbe emici Lastik Profil sonu başlıkları
- Büyüteçli Göstergeler ile kolay okuma

Best Star

Kod	Açıklama	Kutu Adet	Koli Adet	Fiyat
DMX4055	40 cm	10	60	7,91 \$
DMX4056	50 cm	10	60	8,77 \$
DMX4057	60 cm	10	60	9,56 \$
DMX4058	80 cm	10	40	11,60 \$
DMX4059	100 cm	10	30	13,42 \$

Su Terazisi



- Basınca dayanıklı alüminyum gövde
- Yüksek hassasiyet
- 1. sınıf elektostatik boya
- Darbe emici kapaklar

Kod	Açıklama	Kutu Adet	Koli Adet	Fiyat
DMX4724	40 cm	10	60	5,35 \$
DMX4725	50 cm	10	60	5,99 \$
DMX4726	60 cm	10	60	7,00 \$
DMX4727	80 cm	10	60	7,96 \$
DMX4728	100 cm	10	60	9,55 \$



Alüminyum Gönye Terazili

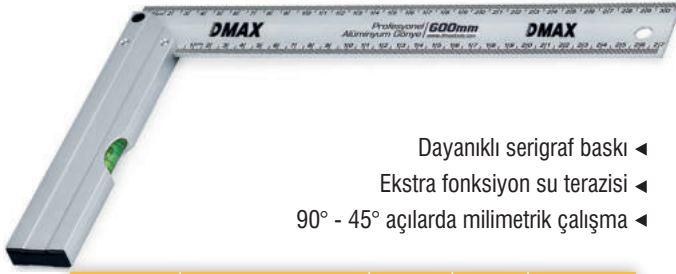

- Dayanıklı serigraf baskı ◀
- Ekstra fonksiyon su terazisi ◀
- 90° - 45° açılarda milimetrik çalışma ◀

Kod	Açıklama	Kutu Adet	Koli Adet	Fiyat
DMX4557	250 mm	10	60	4,78 \$
DMX4558	300 mm	10	60	4,98 \$
DMX4559	350 mm	10	60	5,29 \$
DMX4560	400 mm	10	60	5,80 \$
DMX4561	500 mm	10	60	6,48 \$

Marangoz Gönye



- Dayanıklı serigraf baskı ◀
- 90° - 45° açılarda milimetrik çalışma ◀

Kod	Açıklama	Kutu Adet	Koli Adet	Fiyat
DMX4552	250 mm	12	120	1,48 \$
DMX4553	300 mm	12	120	1,50 \$
DMX4554	350 mm	12	120	1,66 \$
DMX4555	400 mm	12	120	1,84 \$
DMX4556	500 mm	12	120	2,09 \$

Su Terazisi Mini

- ▶ Darbe Emici Kapaklar
- ▶ Yüksek hassasiyet

23 CM
Blisterli Ambalaj

Kod	Açıklama	Kutu Adet	Koli Adet	Fiyat
DMX4147	23 cm	120	240	0,99 \$

Kumpas Mekanik

- ▶ Dayanıklı ve uzun ömürlü gövde

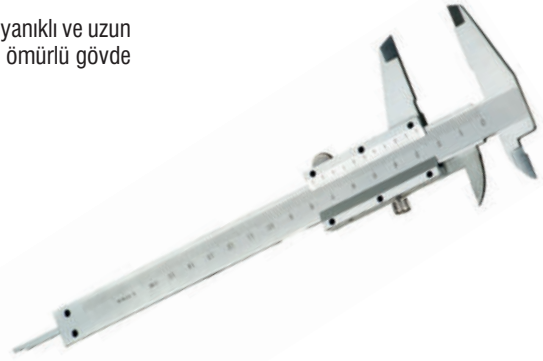
150 MM

Kod	Açıklama	Kutu Adet	Koli Adet	Fiyat
DMX4141	150 mm	1	100	5,89 \$

Boyalı Çırpı İpi

Mavi Kırmızı
115 Grm 30 Metre
Blisterli Ambalaj

Kod	Açıklama	Kutu Adet	Koli Adet	Fiyat
DMX4682	Kırmızı	12	48	2,02
DMX4683	Mavi	12	48	2,02



Kemer Delme Pensesi

Blisterli Ambalaj



8 INCH

Güçlü metal gövde ◀

Kod	Açıklama	Kutu Adet	Koli Adet	Fiyat
DMX4551	8 Inch	10	60	4,90 \$

Kemer Ve Perçin Delme Pensesi

2 Parça



► Güçlü metal gövde

100 Adet Perçin

Blisterli Ambalaj

Kod	Açıklama	Kutu Adet	Koli Adet	Fiyat
DMX4550	2 Parça Set	10	60	7,06 \$

Profesyonel Perçin Tabanca Set

- 4 farklı perçin kalınlığı için değiştirilebilir uç
- Uç değiştirme anahtarı
- Güçlü metal gövde

40 Parça



2,4 mm 4,0 mm

3,2 mm 4,8 mm

Blisterli Ambalaj

Kod	Açıklama	Kutu Adet	Koli Adet	Fiyat
DMX4562	40 Parça	12	48	5,90 \$

Profesyonel Perçin Tabanca

- 4 farklı perçin kalınlığı için değiştirilebilir uç
- Uç değiştirme anahtarı
- Güçlü metal gövde



2,4 mm 4,0 mm

3,2 mm 4,8 mm

Blisterli Ambalaj

Kod	Açıklama	Kutu Adet	Koli Adet	Fiyat
DMX4780	Perçin	12	48	3,99 \$

Boru Makası

Metal Gövde



42 MM

Automatic

Otomatik Bıçak Açma Sistemi

Kod	Açıklama	Kutu Adet	Koli Adet	Fiyat
DMX4694	42 mm	6	48	4,71 \$



Boru Makası

Automatic

Otomatik Bıçak Açma Sistemi

42 MM

Alüminyum
Gövde

► PVC, Pex, Plastik Hortum
Lastik Hortumlar, Naylon, Pv,
Abs, Pe, Boru Kesmek için
Tasarlanmıştır

Kod	Açıklama	Kutu Adet	Koli Adet	Fiyat
DMX4413	42 mm	6	48	8,59 \$

Boru Makası

Manuel

42 MM

Alüminyum
Gövde

► PVC, Pex, Plastik Hortum
Lastik Hortumlar, Naylon, Pv,
Abs, Pe, Boru Kesmek için
Tasarlanmıştır

Kod	Açıklama	Kutu Adet	Koli Adet	Fiyat
DMX4414	42 mm	6	48	6,21 \$

Kaynak Pensesi

600 Amp

600 Amper

► Korumalı yaylı Çeneler ◀
Bakalit Gövde ◀
Güvenli Yalıtım Kompakt Yapı ◀
Yüksek iletkenlik ◀
45°- 90°-180° Açılarda Çalışma ◀

Kod	Açıklama	Kutu Adet	Koli Adet	Fiyat
DMX4216	600 Amper	1	50	4,66 \$

Kaynak Pensesi

400 Amp

400 Amper

► Korumalı yaylı Çeneler ◀
Bakalit Gövde ◀
Güvenli Yalıtım Kompakt Yapı ◀
Yüksek iletkenlik ◀
45°- 90°-180° Açılarda Çalışma ◀

Kod	Açıklama	Kutu Adet	Koli Adet	Fiyat
DMX4215	400 Amper	1	50	2,78 \$

Şase Pensesi

300 Amper

300 Amper

► Yaylı Çeneler ◀
Somun Kablo Bağlantısı ◀
Pozitif Topraklama ◀
Yüksek iletkenlik ◀
Krom Kaplama ◀

Kod	Açıklama	Kutu Adet	Koli Adet	Fiyat
DMX4144	300 Amper	1	100	1,78 \$

Şase Pensesi

500 Amper

500 Amper

► Yaylı Çeneler ◀
Somun Kablo Bağlantısı ◀
Pozitif Topraklama ◀
Yüksek iletkenlik ◀
Krom Kaplama ◀

Kod	Açıklama	Kutu Adet	Koli Adet	Fiyat
DMX4145	500 Amper	1	50	2,70 \$

Boya Tabancası Alttan Depolu

1.8mm



- Mükemmel Otomizasyon
- 1.8mm Nozur Boya Yoğunluk Ayarı
- Tetik Ayarı Basınç Kontrol
- Kolay Kontrol Edilebilir Tetik

1000 / CC

Kod	Açıklama	Kutu Adet	Koli Adet	Fiyat
DMX4186	1000 cc - 1.8mm	1	20	13,82 \$

Boya Tabancası Üstten Depolu

1.8mm



- Mükemmel Otomizasyon
- 1.8mm Nozur Boya Yoğunluk Ayarı
- Tetik Ayarı Basınç Kontrol
- Kolay Kontrol Edilebilir Tetik

600 / CC

Kod	Açıklama	Kutu Adet	Koli Adet	Fiyat
DMX4185	600 cc - 1.8mm	1	20	10,90 \$

Boya Ve Hava Tabancası Seti 5 Parça



- Boya Tabancası Üstten Depolu /600 CC /1.8mm
- Mazot Tabancası (900cc)
- Hava Tabancası
- Saatlik Lastik Şişirme
- 5 mt Spiral Hortum

Kod	Açıklama	Kutu Adet	Koli Adet	Fiyat
DMX4251	5 Parça Set	1	10 Set	33,91 \$

Mazot Tabancası



- Motor, Motor Parçaları veya Yağlı Parçaların Basınçlı Mazot, Benzin vs. Püskürtülerek Temizlenmesinde Kullanılır

900 / CC

Kod	Açıklama	Kutu Adet	Koli Adet	Fiyat
DMX4164	900 cc	2	20	8,87 \$



Gress Tabancası Çift Piston 600 cc

600 CC
Çift Piston
4

Yedek Uçlu

Kod	Açıklama	Kutu Adet	Koli Adet	Fiyat
DMX4691	600 cc	1	12	17,74 \$

Gress Tabancası 500 cc

- Çelik gövde
- Uzun Ömürlü

4

Yedek Uçlu

500 CC

Kod	Açıklama	Kutu Adet	Koli Adet	Fiyat
DMX4323	500 cc	1	20	11,93 \$

Metal Yağdanlık

500 CC
300 CC

- Motor, Motor Parçaları veya Yağ uygulaması gereken parçaların yağlanması için kullanılır

Kod	Açıklama	Kutu Adet	Koli Adet	Fiyat
DMX4408	300 cc	10	60	4,71 \$
DMX4409	500 cc	10	60	5,03 \$

Metal Yağdanlık Spiralli

500 CC
300 CC

- Motor, Motor Parçaları veya Yağ uygulaması gereken parçaların yağlanması için kullanılır

Kod	Açıklama	Kutu Adet	Koli Adet	Fiyat
DMX4410	300 cc	10	60	3,77 \$
DMX4411	500 cc	10	60	4,04 \$

Gres Tabanca Ucu

 Blisterli
Ambalaj

- Metal Gövde
- Dayanıklı Yapı
- Yaylı Mekanizma
- Çift Mandallı



Ürün Tanıtım

Kod	Açıklama	Kutu Adet	Koli Adet	Fiyat
DMX4692	Metal	12	120	2,83 \$

Gres Tabanca Ucu Seti

 Blisterli
Ambalaj

- Metal Gövde
- Dayanıklı Yapı
- Yaylı Mekanizma
- Çift Mandallı



Ürün Tanıtım

Kod	Açıklama	Kutu Adet	Koli Adet	Fiyat
DMX4758	Metal Gövde	12	120	4,80 \$

Köpük Tabancası

 ★ CRV ★
 Çeliğinden Üretilmiştir

- Polüretan köpük tabancası
- Kontrol edilebilir köpük akışıyla temiz ve hassas çalışma
- Spreyleme boşluk dolgu işlemleri hassas ve hızlı bir şekilde gerçekleştirilebilir

Kod	Açıklama	Kutu Adet	Koli Adet	Fiyat
DMX4116	Ayarlı	1	40	11,24 \$

Hava Tabancası



Saattli

Blisterli Ambalaj

12 Bar

Kod	Açıklama	Kutu Adet	Koli Adet	Fiyat
DMX4115	Saattli	10	50	6,91 \$

Hava Tabanca Seti 5 Parça



5 Parça

Blisterli Ambalaj

Kod	Açıklama	Kutu Adet	Koli Adet	Fiyat
DMX4114	5 Parça Set	10	60	4,52 \$

Hava Tabancası



Blisterli Ambalaj

Kod	Açıklama	Kutu Adet	Koli Adet	Fiyat
DMX4701	1 Parça	25	100	3,82 \$

Hava Tabancası Seti Uzun Uçlu



Blisterli Ambalaj

Kod	Açıklama	Kutu Adet	Koli Adet	Fiyat
DMX4702	Uzun Uçlu	25	100	4,14 \$

Hava Basınç Jaki



Euro Girişli

Hortum Girişli

Blisterli Ambalaj

Kod	Açıklama	Kutu Adet	Koli Adet	Fiyat
DMX4213	Euro Girişli	10	100	2,49 \$
DMX4687	Hortum Girişli	10	100	2,49 \$

Hava Basınç Jaki Kamyoncu

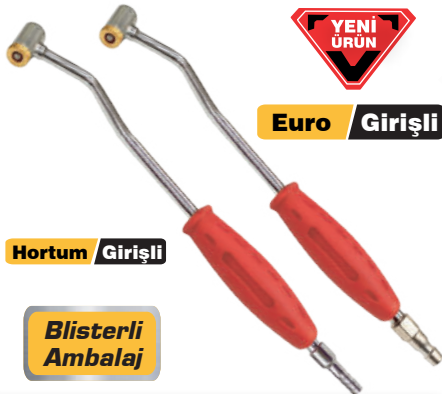

Euro Girişli

Hortum Girişli

Blisterli Ambalaj

Kod	Açıklama	Kutu Adet	Koli Adet	Fiyat
DMX4685	Euro Girişli	12	72	3,27 \$
DMX4686	Hortum Girişli	12	72	3,27 \$

Hava Ölçme Jaki



300 MM

Blisterli Ambalaj

Kod	Açıklama	Kutu Adet	Koli Adet	Fiyat
DMX4214	300 mm	10	100	6,39 \$

Hava Basma Uç Mandalı



8 MM

Kod	Açıklama	Kutu Adet	Koli Adet	Fiyat
DMX4648	2 Pcs 8 mm	20	200	2,64 \$



Hava Kompresörü Çift Girişli



Çakmaklık Girişli

Fiş Girişli

DC 12V-220V 250 PSI

Kod	Açıklama	Kutu Adet	Koli Adet	Fiyat
DMX4675	Çift Girişli	1	10	41,72 \$

Hava Kompresörü Büyük



Çakmaklık Girişli

12V 150 PSI

Çift Silindir

Ürün Özellikleri

- Çift Silindir ◀
- 12V ◀
- 150 PSI ◀
- 5mt. PU hortum ◀
- 70 lt/dk ◀
- Plastik kutu ◀

Kod	Açıklama	Kutu Adet	Koli Adet	Fiyat
DMX4610	Büyük	1	6	48,98 \$

Hava Kompresörü Küçük



Çakmaklık Girişli

12V 100 PSI

Ürün Özellikleri

- Tek Silindir ◀
- 12V ◀
- 100 PSI ◀
- 35 lt/dk ◀

Kod	Açıklama	Kutu Adet	Koli Adet	Fiyat
DMX4609	Küçük	1	8	28,98 \$

Ayak Pompası Çift Piston



55x120 MM

- Ölçü : 55x120 ◀
- Hassas Bar/PSI Göstergeli ◀
- Sağlam Gövde Tasarımı ◀

Kod	Açıklama	Kutu Adet	Koli Adet	Fiyat
DMX4578	Çift Piston	1	15	14,42 \$

Ayak Pompası



45x180 MM

- Ölçü : 45x180 ◀
- Maks Basınç 85 PSI ◀
- Metal Silindir ◀

Kod	Açıklama	Kutu Adet	Koli Adet	Fiyat
DMX4611	45x180 mm	1	50	4,24 \$

Ayak Pompası İnce Piston



- Ölçü : 55x100
- Hassas Bar/PSI Göstergeli
- Sağlam Gövde Tasarımı

Kod	Açıklama	Kutu Adet	Koli Adet	Fiyat
DMX4580	İnce Piston	1	25	5,62 \$

Krom El Pompası Saatli

- ▶ Arabası Lastiği, Motor Lastiği, Bisiklet Lastiği, Arazi Araçları Lastiği, Top vb. Alanlarda Kullanıma Uygundur

- ▶ Ölçü : 38mmx50cm
- ▶ Mil Destekli Gövde
- ▶ Krom Göstergeli Hava Saati

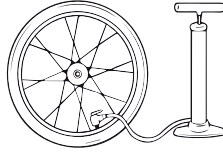

Poşet Askılı Ambalaj



Kod	Açıklama	Kutu Adet	Koli Adet	Fiyat
DMX4642	Krom Saatli	1	20	8,29 \$

El Pompası Ahşap Saplı

- ▶ Araba Lastiği
- ▶ Motor Lastiği
- ▶ Bisiklet Lastiği
- ▶ Arazi Araçları Lastiği
- ▶ Top vb. Alanlarda Kullanıma Uygundur

- ▶ Ölçü : 38mmx50cm
- ▶ Mil Destekli Gövde

Poşet Askılı Ambalaj



Kod	Açıklama	Kutu Adet	Koli Adet	Fiyat
DMX4577	38x50cm	1	20	5,57 \$

El Pompası Premium



Poşet Askılı Ambalaj

- ▶ Araba Lastiği
- ▶ Motor Lastiği
- ▶ Bisiklet lastiği
- ▶ Arazi Araçları Lastiği
- ▶ Top vb. Alanlarda Kullanıma Uygundur
- ▶ Ölçü : 38mmx66cm

Kod	Açıklama	Kutu Adet	Koli Adet	Fiyat
DMX4657	38x66cm	1	30	4,20 \$

El Pompası Plastik Saplı

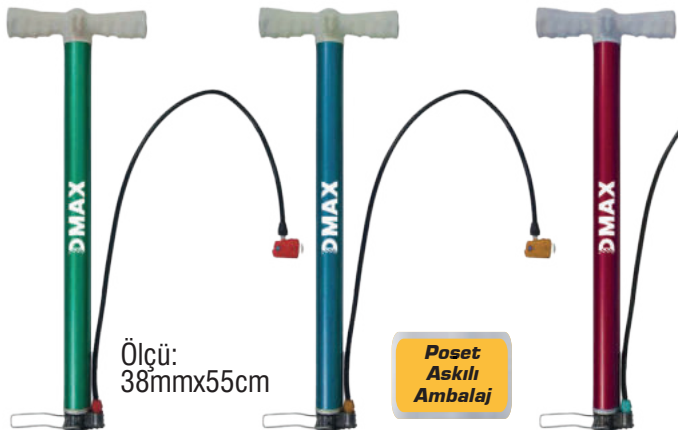

Ölçü: 38mmx55cm

Poşet Askılı Ambalaj

Kod	Açıklama	Kutu Adet	Koli Adet	Fiyat
DMX4581	38x55 cm	25	50	2,70 \$

Bisiklet Pompası



Ölçü: 30mmx30cm

Poşet Askılı Ambalaj

Kod	Açıklama	Kutu Adet	Koli Adet	Fiyat
DMX4582	30x30 cm	50	100	1,62 \$



Bisiklet Pompası Çubuk



Poşet
Askılı
Ambalaj

Ölçü:
22mmx40cm



Kod	Açıklama	Kutu Adet	Koli Adet	Fiyat
DMX4583	22x40 cm	125	250	1,44 \$

Top Şişirme Pompası



Poşet
Askılı
Ambalaj

Ölçü:
30mmx28cm



Kod	Açıklama	Kutu Adet	Koli Adet	Fiyat
DMX4584	30x28 cm	100	200	1,04 \$

Pompa Hortumu

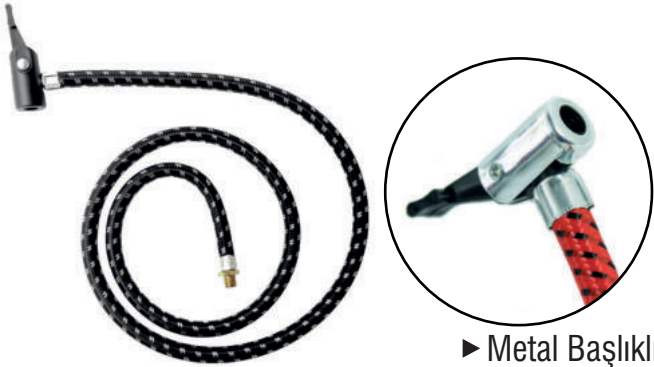

► Siyah Hortum

► Metal Başlıklı



50 cm

► Kırmızı Hortum

Kod	Açıklama	Kutu Adet	Koli Adet	Fiyat
DMX4586	Kırmızı 50 cm	50	500	0,47 \$
DMX4585	Siyah 50 cm	50	500	0,47 \$

Pompa İğne Seti 5 Parça



Blisterli
Ambalaj

Kod	Açıklama	Kutu Adet	Koli Adet	Fiyat
DMX4587	5 Parça Set	20	600	0,62 \$

Cırt Kelepçe Beyaz

2,5 MM

Kod	Açıklama	Kutu Adet	Koli Adet	Fiyat
DMX4282	2,5x100 mm	250	500	0,38 \$
DMX4283	2,5x150 mm	200	400	0,54 \$
DMX4284	2,5x200 mm	150	300	0,82 \$

3,6 MM

Kod	Açıklama	Kutu Adet	Koli Adet	Fiyat
DMX4285	3,6x150 mm	125	250	0,82 \$
DMX4286	3,6x200 mm	100	200	1,10 \$
DMX4287	3,6x250 mm	75	150	1,42 \$
DMX4288	3,6x300 mm	75	150	1,64 \$
DMX4289	3,6x370 mm	50	100	2,17 \$

4,8 MM

Kod	Açıklama	Kutu Adet	Koli Adet	Fiyat
DMX4290	4,8x200 mm	80	160	1,69 \$
DMX4291	4,8x250 mm	70	140	2,22 \$
DMX4292	4,8x300 mm	60	120	2,46 \$
DMX4293	4,8x380 mm	35	70	3,13 \$
DMX4294	4,8x450 mm	35	70	3,84 \$

8,0 MM

Kod	Açıklama	Kutu Adet	Koli Adet	Fiyat
DMX4295	8,0x300 mm	30	60	4,71 \$
DMX4296	8,0x380 mm	25	50	5,89 \$
DMX4297	8,0x450 mm	20	40	6,72 \$
DMX4298	8,8x750 mm	10	20	15,70 \$

6.6
NYLON

85°
40°

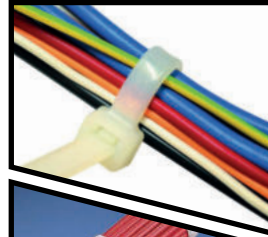

100 Adetli
Paketlerde

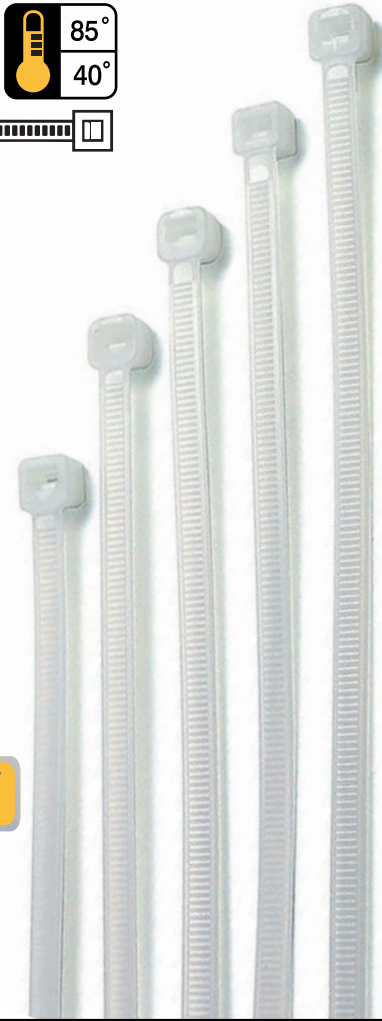

Cırt Kelepçe Siyah

3,6 MM

Kod	Açıklama	Kutu Adet	Koli Adet	Fiyat
DMX4299	3,6x150 mm	125	250	0,82 \$
DMX4300	3,6x200 mm	100	200	1,10 \$
DMX4301	3,6x250 mm	75	150	1,42 \$
DMX4302	3,6x300 mm	75	150	1,64 \$
DMX4303	3,6x370 mm	50	100	2,17 \$

4,8 MM

Kod	Açıklama	Kutu Adet	Koli Adet	Fiyat
DMX4304	4,8x200 mm	80	160	1,69 \$
DMX4305	4,8x250 mm	70	140	2,22 \$
DMX4306	4,8x300 mm	60	120	2,46 \$
DMX4307	4,8x380 mm	35	70	3,13 \$
DMX4308	4,8x450 mm	35	70	3,84 \$

8,0 MM

Kod	Açıklama	Kutu Adet	Koli Adet	Fiyat
DMX4309	8,0x300 mm	30	60	4,71 \$
DMX4310	8,0x380 mm	25	50	5,89 \$
DMX4311	8,0x450 mm	20	40	6,72 \$
DMX4312	8,8x750 mm	10	20	15,70 \$

6.6
NYLON

85°
40°



100 Adetli
Paketlerde





Cırt Kelepçe

3,6 MM Beyaz
6.6
 NYLON

 85°
 40°

Kod	Açıklama	Kutu Adet	Koli Adet	Fiyat
DMX4313	3,6x150 mm	25	500	0,27 \$
DMX4314	3,6x200 mm	25	500	0,39 \$
DMX4315	3,6x250 mm	25	500	0,47 \$
DMX4316	3,6x300 mm	25	500	0,54 \$
DMX4317	3,6x370 mm	25	500	0,75 \$

25'li Paket

3,6 MM Siyah

Kod	Açıklama	Kutu Adet	Koli Adet	Fiyat
DMX4318	3,6x150 mm	25	500	0,27 \$
DMX4319	3,6x200 mm	25	500	0,39 \$
DMX4320	3,6x250 mm	25	500	0,47 \$
DMX4321	3,6x300 mm	25	500	0,54 \$
DMX4322	3,6x370 mm	25	500	0,75 \$

Hortum Kelepçe Seti

10
 Parça Set

2X
 8-18mm
 11-20mm
 13-23mm
 18-25mm
 14-27mm

Kod	Açıklama	Kutu Adet	Koli Adet	Fiyat
DMX4152	10 Parça Set	120	240	1,23 \$

Metal Kelepçe

Kod	Açıklama	Kutu Adet	Koli Adet	Fiyat
DMX2300	8-13 x 8mm	100	2000	0,06 \$
DMX2301	10-16 x 8mm	100	2000	0,06 \$
DMX2302	13-19 x 8mm	100	2000	0,06 \$
DMX2303	16-23 x 8mm	100	2000	0,07 \$
DMX2304	18-25 x 8mm	100	2000	0,07 \$
DMX2305	19-26 x 13mm	100	1000	0,16 \$
DMX2306	20-30 x 13mm	100	1000	0,17 \$
DMX2307	22-36 x 13mm	100	1000	0,17 \$
DMX2308	25-42 x 13mm	100	800	0,18 \$
DMX2309	28-48 x 13mm	100	800	0,18 \$
DMX2310	28-58 x 13mm	100	800	0,18 \$
DMX2311	44-64 x 13mm	100	800	0,19 \$

100 Adetli
 Paketlerde

Gri Asma Kilit

- ▶ Dış Ortama Uygun Sertleştirilmiş Gövdeli Asma Kilit
- ▶ Özel Kimyasal Koruma Boyalı
- ▶ 3 Adet Anahtarlı
- ▶ Paslanmaz Gövde
- ▶ Ekstra Güçlü Yapı



Kod	Açıklama	Kutu Adet	Koli Adet	Fiyat
DMX4590	25 mm	12	600	0,47 \$
DMX4591	32 mm	6	240	0,70 \$
DMX4592	38 mm	6	240	0,77 \$
DMX4593	50 mm	6	120	1,26 \$
DMX4594	63 mm	6	60	1,82 \$



Maximum
Extra Güçlü Güvenlik



Gri Asma Kilit Uzun Kanca

- ▶ Dış Ortama Uygun Sertleştirilmiş Gövdeli Asma Kilit
- ▶ Özel Kimyasal Koruma Boyalı
- ▶ 3 Adet Anahtarlı
- ▶ Paslanmaz Gövde
- ▶ Ekstra Güçlü Yapı



Kod	Açıklama	Kutu Adet	Koli Adet	Fiyat
DMX4595	Uzun 38mm	6	240	0,93 \$
DMX4596	Uzun 50mm	6	120	1,48 \$
DMX4597	Uzun 63mm	6	60	2,10 \$



Maximum
Extra Güçlü Güvenlik



Blisterli Asma Kilit Gri

- ▶ Dış Ortama Uygun Sertleştirilmiş Gövde
- ▶ Özel Koruma Boyalı
- ▶ 3 Adet Anahtarlı
- ▶ Paslanmaz Gövde
- ▶ Ekstra Güçlü Yapı



Premium Quality



Kod	Açıklama	Kutu Adet	Koli Adet	Fiyat
DMX4730	25 mm	12	240	0,74 \$
DMX4731	32 mm	12	144	0,96 \$
DMX4732	38 mm	12	96	1,04 \$
DMX4733	50 mm	12	72	1,48 \$



Maximum
Extra Güçlü Güvenlik





Sarı Asma Kilit

- ▶ Dış Ortama Uygun Sertleştirilmiş Gövdeli Asma Kilit
- ▶ Özel Kimyasal Koruma Boyalı
- ▶ 3 Adet Anahtarlı
- ▶ Paslanmaz Gövde
- ▶ Ekstra Güçlü Yapı



Kod	Açıklama	Kutu Adet	Koli Adet	Fiyat
DMX4598	25 mm	12	600	0,63 \$
DMX4600	38 mm	6	240	1,01 \$

Maximum
Extra Güçlü Güvenlik



Sarı Asma Kilit Uzun Kanca

- ▶ Dış Ortama Uygun Sertleştirilmiş Gövdeli Asma Kilit
- ▶ Özel Kimyasal Koruma Boyalı
- ▶ 3 Adet Anahtarlı
- ▶ Paslanmaz Gövde
- ▶ Ekstra Güçlü Yapı



Kod	Açıklama	Kutu Adet	Koli Adet	Fiyat
DMX4603	Uzun 38mm	6	240	1,18 \$

Maximum
Extra Güçlü Güvenlik



Şifreli Asma Kilit

- ▶ Dış Ortama Uygun Sertleştirilmiş Gövdeli Asma Kilit
- ▶ Özel Kimyasal Koruma Boyalı
- ▶ 3 Adet Anahtarlı
- ▶ Paslanmaz Gövde
- ▶ Ekstra Güçlü Yapı

Kod	Açıklama	Kutu Adet	Koli Adet	Fiyat
DMX4194	No: 20	20	360	1,20 \$
DMX4195	No: 30	20	360	1,48 \$
DMX4196	No: 40	20	360	1,80 \$

Maximum
Extra Güçlü Güvenlik

Blisterli Ambalaj



Motor ve Direksiyon Kilidi Küçük

13mm / 31cm



Kod	Açıklama	Kutu Adet	Koli Adet	Fiyat
DMX4638	13 mm x 31 cm	25	50	4,45 \$

Motor ve Direksiyon Kilidi Büyük

18mm / 29cm



Kod	Açıklama	Kutu Adet	Koli Adet	Fiyat
DMX4639	18 mm x 29 cm	25	50	4,76 \$

Profesyonel Motor Kilidi

25mm / 150cm



Kod	Açıklama	Kutu Adet	Koli Adet	Fiyat
DMX4641	25 mm x 150 cm	10	20	15,09 \$

Motor Kilidi

12mm / 150cm



Kod	Açıklama	Kutu Adet	Koli Adet	Fiyat
DMX4634	12 mm x 150 cm	40	80	3,63 \$

Motor Kilidi (Kalın)

22mm / 150cm



Kod	Açıklama	Kutu Adet	Koli Adet	Fiyat
DMX4636	22mm x 150cm	15	30	11,04

Motor Kilidi Zincirli (Korumalı)

5mm / 100cm



Kod	Açıklama	Kutu Adet	Koli Adet	Fiyat
DMX4632	5 mm x 100 cm	25	50	4,34 \$



Motor Kilidi Ekstra Korumalı

22mm / 150cm

Kod	Açıklama	Kutu Adet	Koli Adet	Fiyat
DMX4631	22 mm x 150 cm	15	30	8,30 \$

Motosiklet ve Scooter Disk Kilidi



- 1 Adet Kilit ◀
- Kilit Taşıma Kılıfı ◀
- Hatırlat Fosforlu Kablo ◀
- Kilidi diske taktıktan sonra, kilid hatırlat kablosunu gaz koluna takip kilit takılıken ani hareket etmenize veya unutmanıza yardımcı olur

Kod	Açıklama	Kutu Adet	Koli Adet	Fiyat
DMX4640	Motor ve Disk Kilit	50	100	6,75 \$

Bisiklet Kilidi Metal Başlıklı

15mm / 80cm

Kod	Açıklama	Kutu Adet	Koli Adet	Fiyat
DMX4633	15 mm x 80 cm	40	80	2,80 \$

Bisiklet Kilidi

12mm / 80cm

Kod	Açıklama	Kutu Adet	Koli Adet	Fiyat
DMX4635	12 mm x 80 cm	50	100	2,01 \$

Pro Şifreli Bisiklet Kilidi

12mm / 80cm

Kod	Açıklama	Kutu Adet	Koli Adet	Fiyat
DMX4637	12mm x 80cm	60	120	3,69 \$

Eko Şifreli Bisiklet Kilidi

7mm / 65cm

Kod	Açıklama	Kutu Adet	Koli Adet	Fiyat
OZS-1832	7mm x 65cm	100	200	2,09 \$

Eko Bisiklet Kilidi

7mm / 65cm

Kod	Açıklama	Kutu Adet	Koli Adet	Fiyat
OZS-1833	7mm x 65cm	80	160	1,44 \$



ZOR ŞARTLARDA %100 KORUMA



SU GEÇİRMEZ

%100 su geçirmez
pvc kumaş



GÜÇLÜ DİKİŞ

Isı ile yapıştırılmış dikişler
ile ekstra koruma



HAFİF VE RAHAR

Hafif yapısı ile gün boyu
konforlu



KAPŞONLU TASARIM

Ayarlanabilir ipli tasarım
ekstra koruma

YAĞMURLUK

Profesyoneller için
tasarlandı.





Yağmurluk Eva

150 Grm
66cm / 115cm

Kod	Açıklama	Kutu Adet	Koli Adet	Fiyat
DMX4588	Sarı	1	100	2,08 \$
DMX4589	Mavi	1	100	2,08 \$

Lüks Yağmurluk

Cepli
66cm / 115cm
255 Grm

Kod	Açıklama	Kutu Adet	Koli Adet	Fiyat
DMX4668	Sarı	1	60	3,81 \$
DMX4669	Yeşil	1	60	3,81 \$

Tek Kullanım Şeffaf Yağmurluk

55 Grm
77cm / 117cm

Kod	Açıklama	Kutu Adet	Koli Adet	Fiyat
DMX4670	Şeffaf	1	300	0,84 \$

Sabit Tezgah Mengenesi

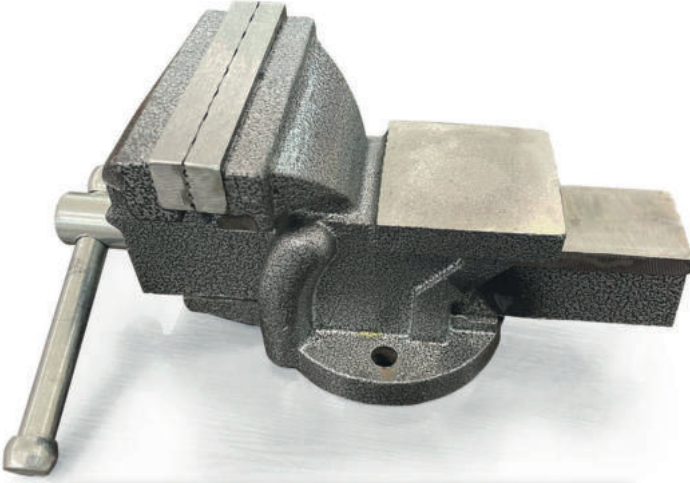

Kod	Açıklama	Kutu Adet	Koli Adet	Fiyat
DMX4106	75 mm	1	4	39,02 \$
DMX4107	100 mm	1	4	43,07 \$
DMX4108	125 mm	1	2	57,73 \$
DMX4109	150 mm	1	2	83,43 \$
DMX4110	200 mm	1	1	122,00 \$

Dönerli Masa Mengenesi



Kod	Açıklama	Kutu Adet	Koli Adet	Fiyat
DMX4111	50 mm	1	10	15,48 \$
DMX4112	60 mm	1	10	16,16 \$

Masa Mengenesi Mini

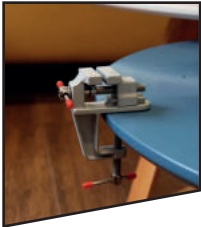

Blisterli Ambalaj

Kod	Açıklama	Kutu Adet	Koli Adet	Fiyat
DMX4148	Mini	30	120	2,58 \$

Mengene Seti 3 Parça

Blisterli Ambalaj



No 1

No 2

No 3

Kod	Açıklama	Kutu Adet	Koli Adet	Fiyat
DMX4153	3 Parça Set	12	72	4,51 \$



Profesyonel Fiber Saplı İşkence

50 MM

Kod	Açıklama	Kutu Adet	Koli Adet	Fiyat
DMX4089	50x150 mm	10	100	3,07 \$
DMX4090	50x200 mm	10	100	3,15 \$
DMX4091	50x250 mm	10	100	3,23 \$
DMX4092	50x300 mm	10	50	3,31 \$

80 MM

Kod	Açıklama	Kutu Adet	Koli Adet	Fiyat
DMX4093	80x200 mm	6	48	5,58 \$
DMX4094	80x250 mm	6	48	5,82 \$
DMX4095	80x300 mm	6	48	5,97 \$
DMX4096	80x400 mm	6	30	6,28 \$

Ahşap Saplı İşkence

50 MM

Kod	Açıklama	Kutu Adet	Koli Adet	Fiyat
DMX4752	50x150 mm	10	100	2,96 \$
DMX4753	50x200 mm	10	100	3,04 \$
DMX4754	50x250 mm	10	100	3,20 \$
DMX4755	50x300 mm	10	50	3,31 \$

Demir Kesme Makası



Kod	Açıklama	Kutu Adet	Koli Adet	Fiyat
DMX4248	14x350 mm	1	30	12,59 \$
DMX4249	18x450 mm	1	20	15,55 \$
DMX4250	24x600 mm	1	10	21,35 \$

Çok Amaçlı Çakmaklı Pürmüz

Blisterli Ambalaj



► Tüm Çakmak Gazı ve Gaz Kartuşlarına uyumludur



Ürün Tanıtım



Kod	Açıklama	Kutu Adet	Koli Adet	Fiyat
DMX4661	Pürmüz	10	100	5,19 \$

Tamirci Cımbız Seti 7 Parça

Blisterli Ambalaj



Kod	Açıklama	Kutu Adet	Koli Adet	Fiyat
OZS-1888	7 Parça Set	24	144	3,58 \$

Lehim Seti



Blisterli Ambalaj

Kod	Açıklama	Kutu Adet	Koli Adet	Fiyat
DMX4142	2 Parça Set	24	240	1,70 \$

Lehim Teli



Blisterli Ambalaj

Kod	Açıklama	Kutu Adet	Koli Adet	Fiyat
DMX4143	Lehim Teli	24	240	1,39 \$



Elektrik İzolasyon Bandı

- 10'lu Paket
- 600 volt ve 80°C kadar dayanıklıdır
- Sarı yaparken kopmaz

19 MM / 10 Yards

Kod	Açıklama	Kutu Adet	Koli Adet	Fiyat
DMX4612	Siyah	25 PK	50 PK	0,33 \$
DMX4613	Beyaz	25 PK	50 PK	0,33 \$
DMX4614	Kırmızı	25 PK	50 PK	0,33 \$
DMX4715	Mavi	25 PK	50 PK	0,33 \$
DMX4716	Yeşil	25 PK	50 PK	0,33 \$
DMX4717	Sarı	25 PK	50 PK	0,33 \$
DMX4615	Kırmızı,Siyah,Mavi,Yeşil Beyaz,Kırmızı	25 PK	50 PK	0,33 \$

18 MM / 6 Yards

Kod	Açıklama	Kutu Adet	Koli Adet	Fiyat
DMX4698	Beyaz	25 PK	50 PK	0,19 \$

Çift Taraflı Akrilik Silikon Bandı

18 MM / 2 Yards

Kod	Açıklama	Kutu Adet	Koli Adet	Fiyat
DMX8690	18 mm x 2 Yard	60	360	0,55 \$

Şeffaf Çift Taraflı Silikon Bant

 Şeffaf
 Daha İnce
 Daha Güçlü

30MM / 2 Metre

Kod	Açıklama	Kutu Adet	Koli Adet	Fiyat
DMX4621	30 mm x 2 mt	144	288	0,91 \$

Teflon Bant

 100%
 SIZDIRMAZLIK
 Yüksek Yoğunluk

- İçme Suyu Hatları İçin Uygundur.
- Sıvı ve Hava Hatlarındaki Tüm Dişli Bağlantılarında Kullanılır.

Kod	Açıklama	Kutu Adet	Koli Adet	Fiyat
DMX4616	10 mt x 12 mm	250	1000	0,14 \$
DMX4617	30 mt x 19 mm	250	500	0,48 \$

Gaz Teflon Bant



- Benzin, Petrol Yağları, Gaz ve Doğalgaz Borularının Bağlantı ve Montajında Kullanılır.

Kod	Açıklama	Kutu Adet	Koli Adet	Fiyat
DMX4618	8 mt x 12 mm	250	1000	0,35 \$

Su Sızdırmaz Bantı



38MM / 3,2 mt



Kod	Açıklama	Kutu Adet	Koli Adet	Fiyat
DMX4665	38mmx3.2 mt	72	144	1,83 \$

Şeffaf Sızdırmaz Bant



- Borular ve bağlantılar
- Pencere ve kapılar
- Banyo ve mutfak



- Şeffaf görünmez yapısı ile iç mekana uygun ve suya dayanıklıdır

38MM / 3,2 mt

Kod	Açıklama	Kutu Adet	Koli Adet	Fiyat
DMX4718	38 mm x 3,2 mt	1	72	1,37 \$

Eriyen Bant



20 MM / 3 Metre



Ürün Tanıtım



- El aletleri
- Sıhhi tesisat
- Kablo tesisatı
- Boru ve hortum

- Kendinden Kaynayıp birleşen yapışkansız tamir bandı

Kod	Açıklama	Kutu Adet	Koli Adet	Fiyat
DMX4699	20 mm x 3 mt	24	288	1,55 \$

Sakız Sızdırmaz Bantı



Sakız band uygulama yaparken zemin kuru ve temiz olmalıdır. Net sonuç için Min. 24 saat beklenmelidir.

Kod	Açıklama	Kutu Adet	Koli Adet	Fiyat
DMX4740	48 mm x 2 mt	12	120	1,16 \$
DMX4741	72 mm x 2 mt	12	96	1,62 \$
DMX4742	96 mm x 2 mt	6	60	2,10 \$

Derz Bantı

Tam Metraj



Kod	Açıklama	Kutu Adet	Koli Adet	Fiyat
DMX4662	48mm x 45Yards	1	90	1,41 \$
DMX4663	48mm x 90Yards	1	60	2,73 \$
DMX4664	96mm x 90Yards	1	30	5,72 \$



Kaydırmaz Bant

25 MM / 50 MM

Kod	Açıklama	Kutu Adet	Koli Adet	Fiyat
DMX4622	25 mm x 5 mt	72	144	1,35 \$
DMX4677	25 mm x 10 mt	36	72	2,18 \$
DMX4623	25 mm x 15 mt	36	72	3,45 \$
DMX4678	25 mm x 25 mt	24	48	5,39 \$
DMX4624	50 mm x 5 mt	36	72	2,36 \$
DMX4679	50 mm x 10 mt	18	36	4,48 \$
DMX4625	50 mm x 15 mt	18	36	6,51 \$
DMX4680	50 mm x 25 mt	12	24	10,78 \$

Kaydırmaz Bant Sarı Siyah



Kod	Açıklama	Kutu Adet	Koli Adet	Fiyat
DMX4626	25 mm x 15 mt	36	72	4,24 \$
DMX4627	50 mm x 15 mt	18	36	8,36 \$

Fosforlu Kaydırmaz Bant

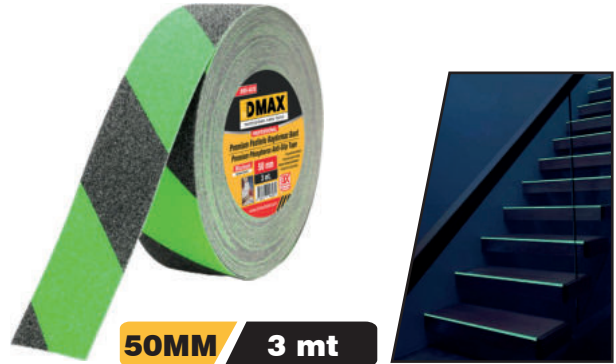
50MM / 3 mt

Kod	Açıklama	Kutu Adet	Koli Adet	Fiyat
DMX4628	50mm x 3mt	36	72	4,40 \$

DMAX

POWER and HAND TOOLS

Güvenli Adımlar İçin Profesyonel Çözüm

DMAX Kaydırmaz Bant

Yüksek tutuş. Dayanıklı yüzey. Güvenli kullanım.



Merdivenler, rampalar ve kaygan zeminler için ideal



Tek Vantuz Plastik Gövde



Ø12,5 cm



max 40 KG Mobilya Furniture Cam Glass Fayans Tiles

Kod	Açıklama	Kutu Adet	Koli Adet	Fiyat
DMX4782	Tekli	1	30	3,06 \$

İkili Vantuz Plastik Gövde



Ø12,5 cm



max 80 KG Mobilya Furniture Cam Glass Fayans Tiles

Kod	Açıklama	Kutu Adet	Koli Adet	Fiyat
DMX4065	İkili	1	24	6,64 \$

Üçlü Vantuz Plastik Gövde



Ø12,5 cm



max 120 KG Mobilya Furniture Cam Glass Fayans Tiles

Kod	Açıklama	Kutu Adet	Koli Adet	Fiyat
DMX4066	Üçlü	1	20	9,92 \$

Tek Vantuz Alüminyum Gövde



Ø12,5 cm



max 50 KG Mobilya Furniture Cam Glass Fayans Tiles

Kod	Açıklama	Kutu Adet	Koli Adet	Fiyat
DMX4783	Tekli	1	30	6,10 \$

İkili Vantuz Alüminyum Gövde



Ø12,5 cm



max 120 KG Mobilya Furniture Cam Glass Fayans Tiles

Kod	Açıklama	Kutu Adet	Koli Adet	Fiyat
DMX4067	İkili	1	24	10,24 \$

Üçlü Vantuz Alüminyum Gövde



Ø12,5 cm



max 130 KG Mobilya Furniture Cam Glass Fayans Tiles

Kod	Açıklama	Kutu Adet	Koli Adet	Fiyat
DMX4068	Üçlü	1	20	17,05 \$



Mini Gravür Kalıpcı Taşlama Setleri

Blisterli Ambalaj



5 Parça



10 Parça

105 Parça

Kod	Açıklama	Kutu Adet	Koli Adet	Fiyat
DMX4134	5 Parça / Set	20	200	1,60 \$
DMX4135	10 Parça / Set	16	120	2,47 \$
DMX4136	105 Parça/Set	25	120	4,09 \$

Taşlama ve Fırçalama Gravür Seti 12 Parça

Blisterli Ambalaj



12 Parça

Kod	Açıklama	Kutu Adet	Koli Adet	Fiyat
DMX4137	12 Parça / Set	25	100	2,58 \$

Döner Ahşap Törpü Seti 5 Parça

Blisterli Ambalaj



Kod	Açıklama	Kutu Adet	Koli Adet	Fiyat
DMX4139	5 Parça	20	100	2,45 \$

Elmas Metal Kalıpcı Taşlama Seti 5 Parça



Kod	Açıklama	Kutu Adet	Koli Adet	Fiyat
DMX4138	5 Parça	10	100	5,19 \$

Boru Çıkarıcı

1/2 25m-35m

3/4 35m-50m



Blisterli Ambalaj



Ürün Tanıtım

Kod	Açıklama	Kutu Adet	Koli Adet	Fiyat
DMX4576	1/2-3/4	10	100	2,30 \$

Matkap Uçlu Boru Çıkartıcı



1/2 25-35mm

3/4 35-50mm

Blisterli Ambalaj



Ürün Tanıtım

Kod	Açıklama	Kutu Adet	Koli Adet	Fiyat
DMX4774	1/2-25-35mm	10	100	2,80 \$
DMX4775	3/4-35-50mm	10	100	3,00 \$

Pprc Boru Geniştirme ve Delme Bits Uçlu Matkap Uç Seti



Blisterli Ambalaj

YENİ ÜRÜN



Ürün Tanıtım

15-19 mm 18-24 mm 24-31 mm

Kod	Açıklama	Kutu Adet	Koli Adet	Fiyat
DMX4760	12 Parça / Set	25	100	4,95 \$

Pprc Boru Dış Açma Seti



İç Dış Açma
1/2"-3/4"

Dış Dış Açma
20-25mm

3 PARÇA

HEX



Ürün Tanıtım

Kod	Açıklama	Kutu Adet	Koli Adet	Fiyat
DMX4762	1 - 3/4	20	120	3,64 \$

Pprc Boru Dıştan Dış Açma Aparat Seti

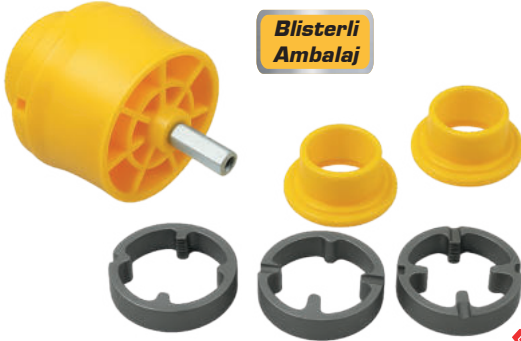

Blisterli Ambalaj



Ürün Tanıtım

1" 1/2" 3/4"

YENİ ÜRÜN

Kod	Açıklama	Kutu Adet	Koli Adet	Fiyat
DMX4761	6 Parça	30	60	5,09 \$

Profesyonel Motor Eğesi



8x200mm 4.0

Demir

Plastik

Ahşap

Metall

Kod	Açıklama	Kutu Adet	Koli Adet	Fiyat
DMX4154	8x200mm 4.0	12	576	0,84 \$

Profesyonel Motor Eğesi



8x200mm 4.8

Demir

Plastik

Ahşap

Metall

Kod	Açıklama	Kutu Adet	Koli Adet	Fiyat
DMX4155	8x200mm 4.8	12	576	0,84 \$

Profesyonel Motor Eğesi



8x200mm 5.5

Demir

Plastik

Ahşap

Metall

Kod	Açıklama	Kutu Adet	Koli Adet	Fiyat
DMX4156	8x200mm 5.5	12	576	0,84 \$

Yassı Eğe Blisterli



8 Inch

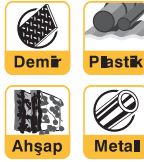

Kod	Açıklama	Kutu Adet	Koli Adet	Fiyat
DMX4157	8 Inch	12	120	2,36 \$

Üçgen Eğe Blisterli



8 Inch

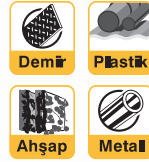

Kod	Açıklama	Kutu Adet	Koli Adet	Fiyat
DMX4158	8 Inch	12	120	2,12 \$

Yuvarlak Eğe Blisterli



8 Inch

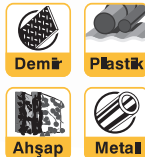

Kod	Açıklama	Kutu Adet	Koli Adet	Fiyat
DMX4159	8 Inch	12	120	2,06 \$

Mini Eğe Seti 6 Parça

6 Inch



Kod	Açıklama	Kutu Adet	Koli Adet	Fiyat
DMX4160	6 Inch	20	200	2,71 \$

Pro Mini Eğe Seti 6 Parça

6 Inch

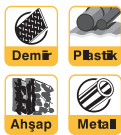

Kod	Açıklama	Kutu Adet	Koli Adet	Fiyat
DMX4161	6 Inch	12	120	3,60 \$

Eğe Seti 5 Parça

8 Inch

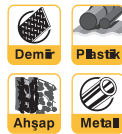

Kod	Açıklama	Kutu Adet	Koli Adet	Fiyat
DMX4162	8 Inch	6	24	10,41 \$



Sulama Tabanca Seti

8 Fonksiyon / 5 Parça



**Konforlu
Tutuş**

- ▶ 1/2" Tabanca bağlantı adaptörü
- ▶ 1/2" Stoplu hortum adaptörü
- ▶ 1/2" Hortum bağlantı adaptörü
- ▶ 1/2" 3/4" Musluk adaptörü

8 Fonksiyon

Kod	Açıklama	Kutu Adet	Koli Adet	Fiyat
DMX4270	5 Parça	24	48	5,05 \$

Sulama Tabanca Seti

2 Fonksiyon / 5 Parça



**Konforlu
Tutuş**

- ▶ 1/2" Tabanca bağlantı adaptörü
- ▶ 1/2" Stoplu hortum adaptörü
- ▶ 1/2" Hortum bağlantı adaptörü
- ▶ 1/2" 3/4" Musluk adaptörü

2 Fonksiyon

Kod	Açıklama	Kutu Adet	Koli Adet	Fiyat
DMX4268	5 Parça	24	48	4,44 \$

Sulama Tabancası

8 Fonksiyon / 3 Parça



**Konforlu
Tutuş**

- ▶ 1/2" Tabanca bağlantı adaptörü
- ▶ 1/2" Hortum bağlantı adaptörü



8 Fonksiyon

Kod	Açıklama	Kutu Adet	Koli Adet	Fiyat
DMX4269	3 Parça	24	48	4,38 \$

Sulama Tabanca Seti

2 Fonksiyon / 3 Parça



**Konforlu
Tutuş**

- ▶ 1/2" Tabanca bağlantı adaptörü
- ▶ 1/2" Hortum bağlantı adaptörü



2 Fonksiyon

Kod	Açıklama	Kutu Adet	Koli Adet	Fiyat
DMX4267	3 Parça	24	48	4,21 \$

Otomatik Metal Uçlu Tabanca



**Konforlu
Tutuş**



Kod	Açıklama	Kutu Adet	Koli Adet	Fiyat
DMX4271	Metal Uçlu	36	72	4,23 \$

Metal Tabanca Profesyonel / Otomatik



**Konforlu
Tutuş**



Kod	Açıklama	Kutu Adet	Koli Adet	Fiyat
DMX4272	Metal	36	72	7,57 \$

Hortum Eki



1/2 3/4



Kod	Açıklama	Kutu Adet	Koli Adet	Fiyat
DMX4273	1/2	150	300	0,46 \$
DMX4274	3/4	150	300	0,57 \$

Hortum Adaptörü Stoplu



1/2 3/4



Kod	Açıklama	Kutu Adet	Koli Adet	Fiyat
DMX4275	1/2	150	300	0,60 \$
DMX4276	3/4	150	300	0,66 \$

Musluk ve Hortum Adaptörü



1/2 3/4



Kod	Açıklama	Kutu Adet	Koli Adet	Fiyat
DMX4277	1/2-3/4	150	300	0,44 \$

Sulama ve Musluk Aparat Seti 4 Parça



1/2 4 Parça



Kod	Açıklama	Kutu Adet	Koli Adet	Fiyat
DMX4278	1/2 - 4 Parça	60	120	1,88 \$

Çift Çıkışlı ve Vanalı Musluk Adaptörü



► Tüm 1/2 - 3/4 Musluk ve Hortum Girişlerine Uyumludur

1/2 3/4

Kod	Açıklama	Kutu Adet	Koli Adet	Fiyat
DMX4279	1/2-3/4	60	120	2,04 \$

Tazyikli Hortum Aparatı



Blisterli Ambalaj

1/2 3/4

- Çiçekleri sula
- Arabayı yıka
- Metal gövde
- Çeşitli püskürtme



Ürün Tanıtım

► Tüm 1/2 - 3/4 Musluk ve Hortum Girişlerine uyumludur



Kod	Açıklama	Kutu Adet	Koli Adet	Fiyat
DMX4198	1/2-3/4	50	200	3,07 \$



Spring Fiskiyeye Metal-Plastik



Kod	Açıklama	Kutu Adet	Koli Adet	Fiyat
DMX4280	Metal	24	48	9,55 \$
DMX4281	Plastik	24	48	2,90 \$

Sulama ve Yıkama Tabancası Fonksiyonlu



- ▶ Sabun Hazneli
- ▶ 8 Fonksiyon
- ▶ Konforlu Tutuş
- ▶ Darbeye Dayanıklı Gövde



Kod	Açıklama	Kutu Adet	Koli Adet	Fiyat
DMX4223	8 Fonksiyonlu	1	30	5,81 \$

Sihirli Hortumlu Sulama Tabanca Seti

15 mt Uzama
Kapasitesi

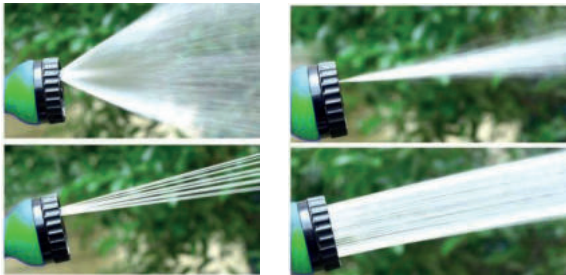

Sihirli Hortum'un tekrar eski haline dönebilmesi için kullanım sonrası min 10 dk. beklemenizi tavsiye ederiz.



Kod	Açıklama	Kutu Adet	Koli Adet	Fiyat
DMX4412	15 mt	1	30	16,37 \$

Çim Biçme Makası

- ▶ Ergonomik Kauçuk Tutma Kolları
- ▶ Yapışmaz Teflon Kaplama Bıçaklar
- ▶ Özel Bilenmiş Ağız Yapısı
- ▶ Uzun Ömürlü



Sabit

Kod	Açıklama	Kutu Adet	Koli Adet	Fiyat
DMX4228	Sabit	1	24	9,09 \$

Çim Biçme Makası Teleskopik

- ▶ Ergonomik Kauçuk Tutma Kolları
- ▶ Yapışmaz Teflon Kaplama Bıçaklar
- ▶ Özel Bilenmiş Ağız Yapısı
- ▶ Uzun Ömürlü



Teleskopik

Kod	Açıklama	Kutu Adet	Koli Adet	Fiyat
DMX4227	Teleskopik	1	24	11,11 \$

Dal Budama Makası

- ▶ Ergonomik Kauçuk Tutma Kolları
- ▶ Yapışmaz Teflon Kaplama Bıçaklar
- ▶ Özel Bilenmiş Ağız Yapısı
- ▶ Uzun Ömürlü



Sabit

Kod	Açıklama	Kutu Adet	Koli Adet	Fiyat
DMX4231	Sabit	1	12	16,26 \$

Dal Budama Makası Teleskopik

- ▶ Ergonomik Kauçuk Tutma Kolları
- ▶ Yapışmaz Teflon Kaplama Bıçaklar
- ▶ Özel Bilenmiş Ağız Yapısı
- ▶ Uzun Ömürlü



Teleskopik

Kod	Açıklama	Kutu Adet	Koli Adet	Fiyat
DMX4232	Teleskopik	1	12	23,29 \$

Tırpan Misinası Altıgen



Altıgen



Kod	Açıklama	Kutu Adet	Koli Adet	Fiyat
DMX4326	3.0mm x 50 mt	10	30	6,05 \$
DMX4327	3.3mm x 41 mt	10	30	6,05 \$
DMX4328	3.5mm x 37 mt	10	30	6,05 \$
DMX4329	4.0mm x 30 mt	10	30	6,05 \$

Tırpan Misinası Çelik Telli



Çelik Telli



Kod	Açıklama	Kutu Adet	Koli Adet	Fiyat
DMX4330	3.3mm x 26 mt	10	30	10,10 \$



Dekupaj Ağız Ahşap (T-144D)



T-144D

5 Parça

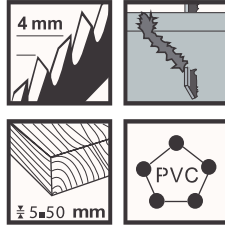

- ▶ Keskinleştirilmiş Testere Ağız
- ▶ Hızlı ve Sert Kesim
- ▶ 100mm x 7.5mm

Kod	Açıklama	Kutu Adet	Koli Adet	Fiyat
DMX4179	T-144 D/5 Parça	100 PK	400 PK	1,21 \$

Dekupaj Ağız Metal (T-118A)

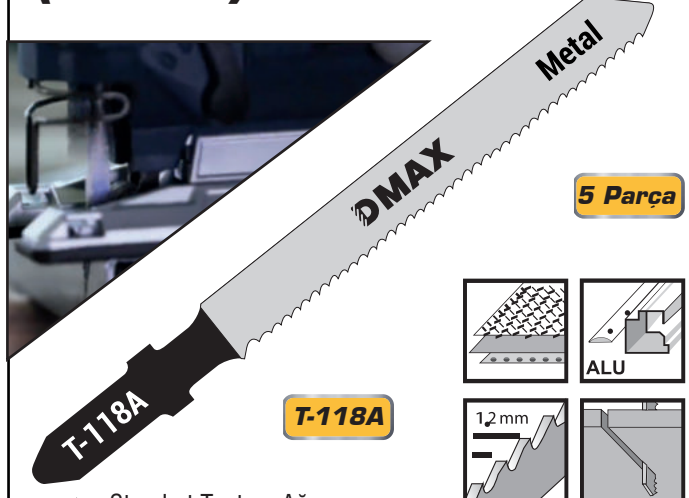

5 Parça

T-118A

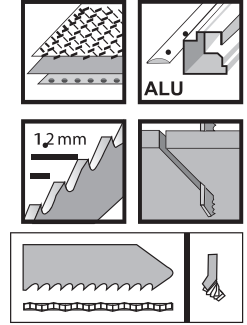

- ▶ Standart Testere Ağız
- ▶ Dalgalı Set
- ▶ Hızlı ve Sert Kesim
- ▶ 77mm x 7.9mm

Kod	Açıklama	Kutu Adet	Koli Adet	Fiyat
DMX4178	T-118A / 5 Parça	100 PK	400 PK	1,25 \$

Tilki Kuyruğu Ağız Paslanmaz (S-1211K)

KEMİK
KESERBUZ
KESER

HARDPOINT

HIZLI
KESİM

5 Parça

S-1211K

- ▶ Kemik ve Buz Kesimi için Uygundur

Kod	Açıklama	Kutu Adet	Koli Adet	Fiyat
DMX4180	5 Parça	25 PK	100 PK	10,74 \$

Tilki Kuyruğu Metal (S-922EF)

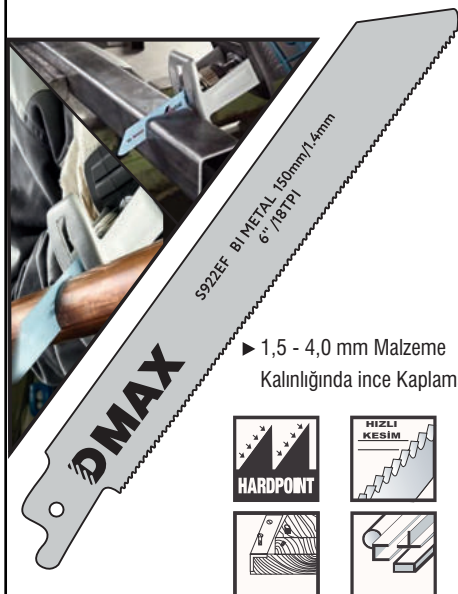

- ▶ 1,5 - 4,0 mm Malzeme Kalınlığında ince Kaplama

HARDPOINT

HIZLI
KESİM

5 Parça

S-922EF

- ▶ 1,5 - 4,0 mm Malzeme Kalınlığında ince Kaplama
- ▶ Tam Borular ve Profiller Ø 5.0 -100.0 mm Hızlı kesim

Kod	Açıklama	Kutu Adet	Koli Adet	Fiyat
DMX4181	5 Parça	25 PK	100 PK	6,89 \$

Tilki Kuyruğu Ağız Ağaç ve Metal (S-1122HF)



- ▶ Çok Amaçlı Kesimler için
- ▶ Yüksek kesme Performanslı Çapraz ve Frezelenmiş Dişler

HARDPOINT

HIZLI
KESİM

5 Parça

S-1122HF

- ▶ 1,5 - 4,0 mm Malzeme Kalınlığında ince Kaplama
- ▶ Tam Borular ve Profiller Ø 5.0 -100.0 mm Hızlı kesim

Kod	Açıklama	Kutu Adet	Koli Adet	Fiyat
DMX4182	5 Parça	25 PK	100 PK	9,32 \$

Tilki Kuyruğu Ahşap (S1531-L)

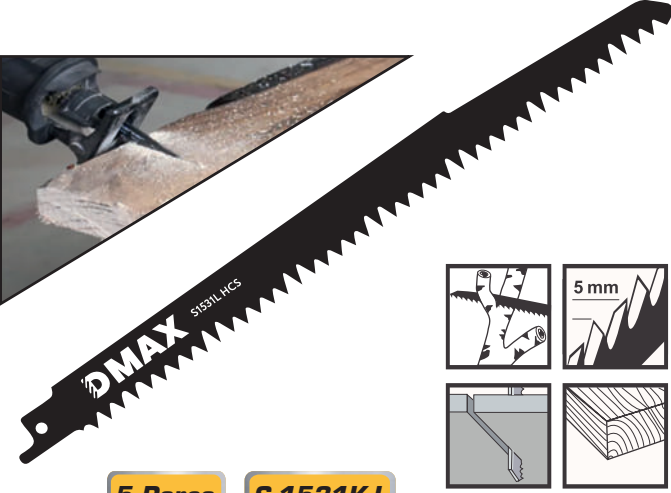

5 Parça S-1531K-L

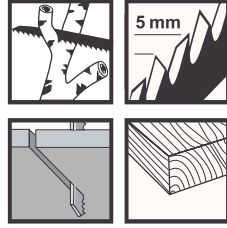

- Yüksek Kesme Performansı
- Çapraz ve Freezlenmiş Dişler
- 240 mm x 5 mm
- Kaba Kesimler için Uygundur
- Ahşap ve Ağaçların Hızlı Kesimi ve Budaması için kullanılır

Kod	Açıklama	Kutu Adet	Koli Adet	Fiyat
DMX4183	5 Parça	25 PK	100 PK	7,81 \$

Tilki Kuyruğu Tuğla Gaz Beton (S-1243HM-305mm)



1 Parça S-1243Hm 305 mm



- Yüksek Kesme Performansı
- Uzun Ömür
- 305mm / 12.7mm
- 305mm Tilki Kuyruğu Bıçağı
- Tuğla, Briket, Ytong Kesimi için Uygundur

Kod	Açıklama	Kutu Adet	Koli Adet	Fiyat
DMX4184	305 mm/1 Adet	25	100	11,87 \$

Kolastar Ağzı Düz

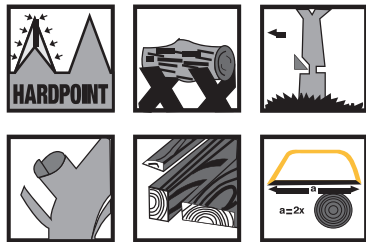
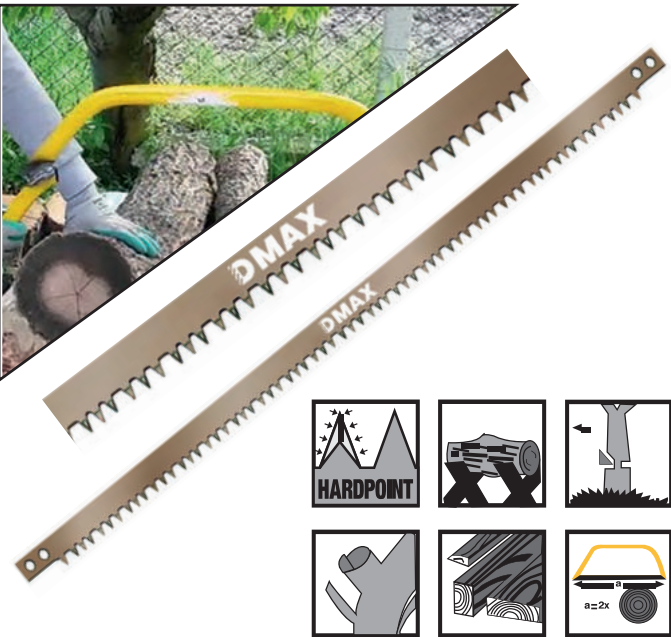

- Yay Çeliği
- Düz Diş
- Pozitif VARIO Dişler

Kod	Açıklama	Kutu Adet	Koli Adet	Fiyat
DMX4243	Düz 61 cm	20	200	1,19 \$
DMX4244	Düz 76 cm	20	200	1,36 \$

Kolastar Ağzı Çatal

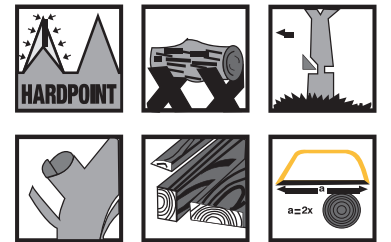
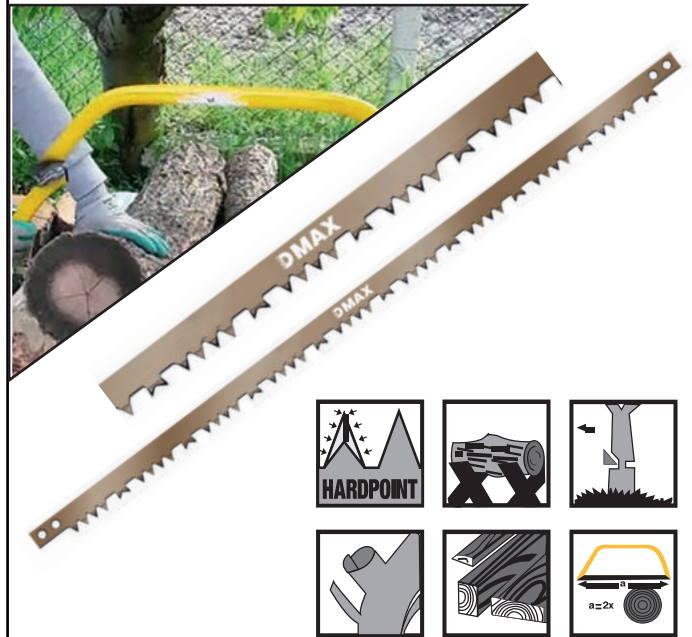

- Yay Çeliği
- Düz Diş
- Pozitif VARIO Dişler

Kod	Açıklama	Kutu Adet	Koli Adet	Fiyat
DMX4245	Çatal 61 cm	20	200	1,19 \$
DMX4246	Çatal 76 cm	20	200	1,36 \$



Ağaç Kesme Motor Zinciri

- ▶ Yüksek Performans
- ▶ Kesici Ağızlar, Geri Tepmeyi Azaltan Özel Parçalar
- ▶ Üst Kesici Ağız Üzerinde bulunan çizikler Sayesinde Doğru ve Kolay bileme Sağlar
- ▶ Taşıyıcıda Yağlama delikleri, En iyi Yağlamayı Sağlar

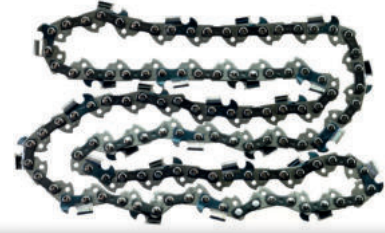

Teknik Özellikler	DMX4262	DMX4264	DMX4265	DMX4266
Zincir Ölçüsü	3/25	3/25	3/8	3/8
Ayak Kalınlığı	1,3 mm	1,3 mm	1,3 mm	1,3 mm
Uzunluk	550 mm	630 mm	630 mm	650 mm
Diş Sayısı	34 Diş	38 Diş	34 Diş	36 Diş
Zincir Tipi	Köşeli	Köşeli	Köşeli	Köşeli
Kutu - Koli	10/100	10/100	10/50	10/50
Fiyat	7,09 \$	7,39 \$	9,26 \$	9,83 \$

Çok Amaçlı Kesme Zımparalama Aparatı



Ürün Tanıtım

Kod	Açıklama	Kutu Adet	Koli Adet	Fiyat
DMX4756	10 Parça	1	50	9,55 \$

Çok Amaçlı Disk Aparatı 115 mm



Ürün Tanıtım

Sunta Testeresi - Inox ve Diğer Tüm Diskler için Matkaplara Uygundur

Kod	Açıklama	Kutu Adet	Koli Adet	Fiyat
DMX4757	115 mm	1	50	8,59 \$

Seyyar Akü Led Lamba Metal



- ▶ 4 mt Seyyar kablo uzunluğu
- ▶ 12 Volt / 5 Watt Led Lamba
- ▶ İki adet kutup başı
- ▶ Açma-Kapama düğmesi

12 V / 5W

Blisterli Ambalaj

4 Metre Kablo

Kod	Açıklama	Kutu Adet	Koli Adet	Fiyat
OZS-1846	5 Watt	1	50	3,37 \$

Seyyar Akü Led Lamba Plastik



- ▶ İki adet kutup başı
- ▶ Açma-Kapama düğmesi
- ▶ 4 mt Seyyar kablo uzunluğu
- ▶ 12 Volt / 5 Watt Led Lamba

12 V / 5W

Blisterli Ambalaj

4 Metre Kablo

Kod	Açıklama	Kutu Adet	Koli Adet	Fiyat
OZS-1857	5 Watt	1	50	2,66 \$

Demir Testere Ağzı

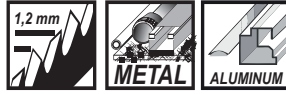
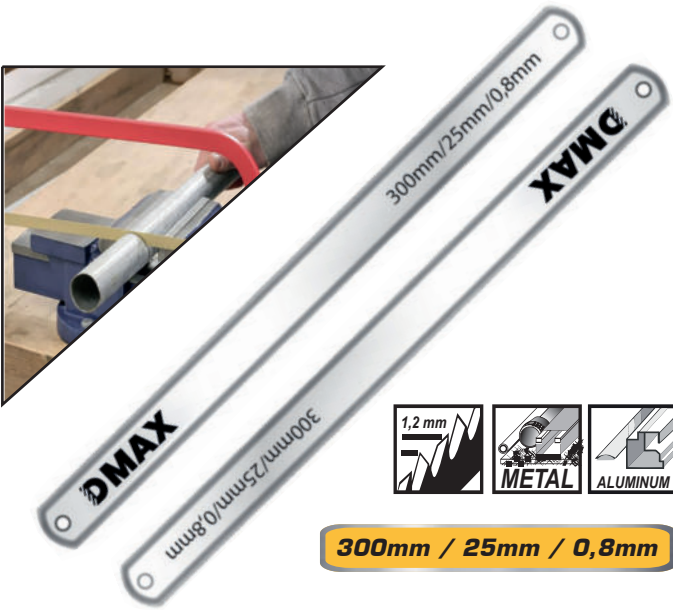

300mm / 25mm / 0,8mm

- ▶ 300 mm / 25mm / 0,8 mm
- ▶ Pozitif VARIO Dişler
- ▶ Çift Ağzı
- ▶ Metal boru ve Ne-Metallerin Manuel kesimi

Kod	Açıklama	Kutu Adet	Koli Adet	Fiyat
DMX4242	Geniş Ağzı	40	600	0,23 \$

Demir Testere Kolu Ağzılı (300mm / 12")



300mm / 12"

- ▶ HSS M2 Yüksek Hız Çeliği
- ▶ Pozitif VARIO Dişler
- ▶ Çift Ağzı

Kod	Açıklama	Kutu Adet	Koli Adet	Fiyat
DMX4241	300 mm 12"	15	60	3,04 \$

Profesyonel Testere Kolu Ağzılı (300 mm / 12")

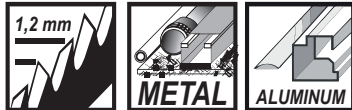

Profesyonel

- ▶ HSS M2 Yüksek Hız Çeliği
- ▶ Pozitif VARIO Dişler
- ▶ Çift Ağzı
- ▶ Uzun Ömürlü Somonlu Kelebek
- ▶ Metal, Boru ve NE-Metallerin Manuel Kesimi
- ▶ Kolay Takılabilir Pimli Somun

Kod	Açıklama	Kutu Adet	Koli Adet	Fiyat
DMX4575	300 mm 12"	12	48	3,17 \$

Kolastar Testere Kolu Ağzılı

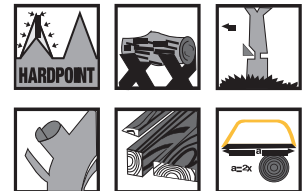
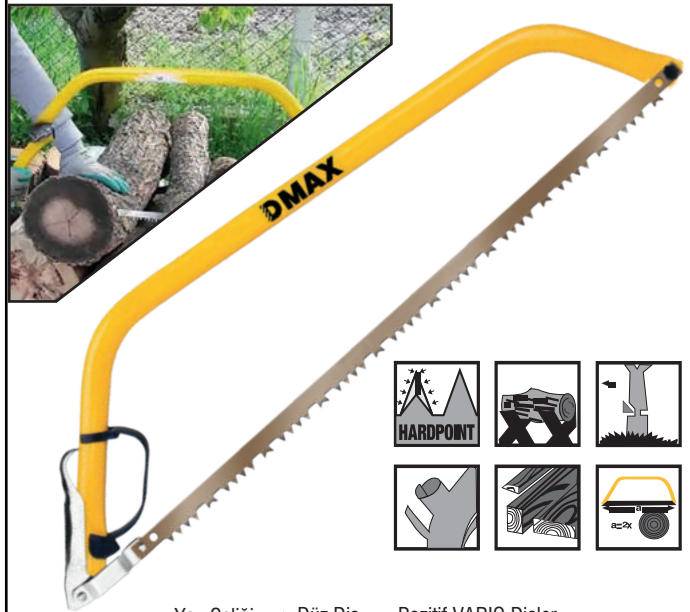

- ▶ Yay Çeliği
- ▶ Düz Diş
- ▶ Pozitif VARIO Dişler

Kod	Açıklama	Kutu Adet	Koli Adet	Fiyat
DMX4324	61 cm	1	24	4,97 \$
DMX4325	76 cm	1	24	5,65 \$



Gaz Beton Testeresi 550mm

- ▶ Çeliğe Kaynaklı Özel Bilenmiş Elmas Dişler
- ▶ Gaz Beton ve Tuğla kesimi
- ▶ Yüksek Karbonlu Çelik
- ▶ Hızlı Kesim



Kod	Açıklama	Kutu Adet	Koli Adet	Fiyat
DMX4252	550 mm	6	24	14,92 \$

Profesyonel Pala Testere 500mm

- ▶ İki Eksenli Özel Bileme
- ▶ 50 Rockwell Yay Çeliği
- ▶ Hızlı Kesim

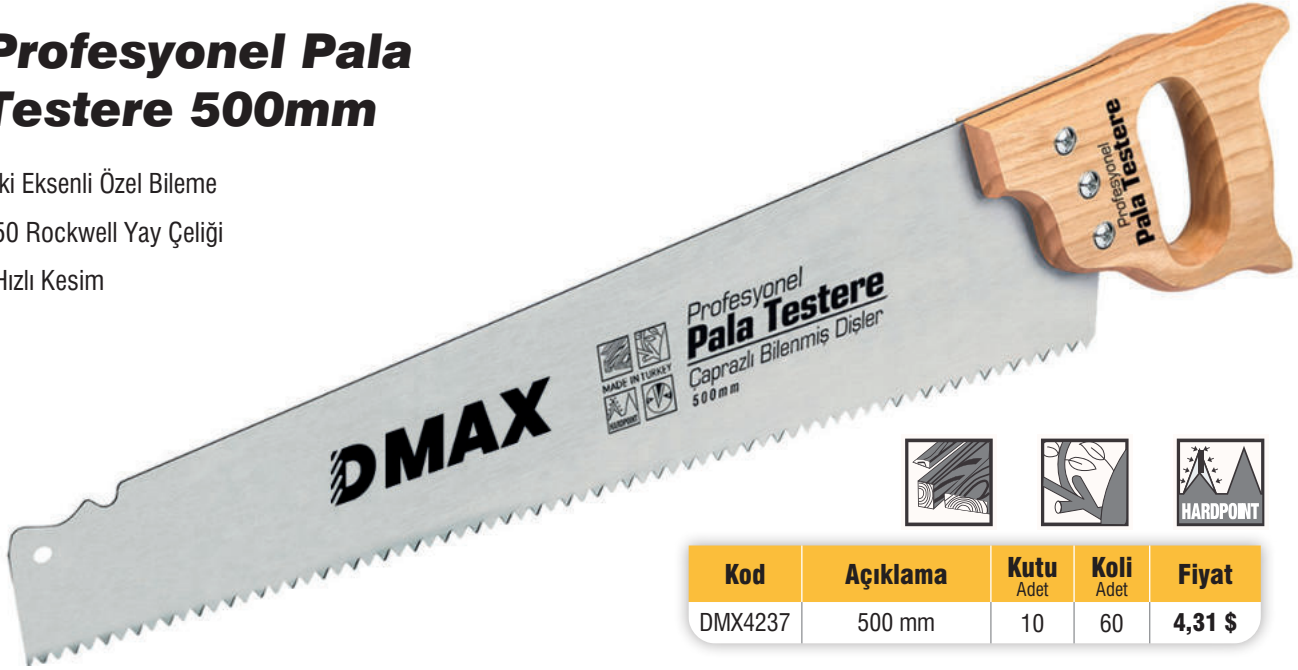

Kod	Açıklama	Kutu Adet	Koli Adet	Fiyat
DMX4237	500 mm	10	60	4,31 \$

Fiber Saplı Pala Testere

- ▶ İki Eksenli Özel Bileme
- ▶ Yüksek Karbonlu Çelik
- ▶ Hızlı Kesim
- ▶ Çeliğe Kaynaklı Özel Bilenmiş Elmas Dişler



Kod	Açıklama	Kutu Adet	Koli Adet	Fiyat
DMX4238	No: 12	10	60	2,87 \$
DMX4239	No: 18	10	60	3,52 \$
DMX4240	No: 20	10	60	3,66 \$

Budama Testeresi 300 mm

- ▶ Isıl İşlem Uygulanmış Dişler
- ▶ Yüksek Karbon Çelik
- ▶ Üç Eksenli Özel Bileme



300 MM



Kod	Açıklama	Kutu Adet	Koli Adet	Fiyat
DMX4234	300 mm 12"	30	60	2,51 \$

Budama Testeresi Kılıflı /300mm

- ▶ Isıl İşlem Uygulanmış Dişler
- ▶ Üç Eksenli Özel Bileme
- ▶ Yüksek Karbon Çelik



300 MM

Kılıflı



Kod	Açıklama	Kutu Adet	Koli Adet	Fiyat
DMX4233	300 mm	24	48	3,64 \$

Budama Testeresi Ağaç Saplı / 300mm

- ▶ Isıl İşlem Uygulanmış Dişler
- ▶ Yüksek Karbon Çelik
- ▶ Üç Eksenli Özel Bileme
- ▶ 50 Rockwell Yay Çeliği



300 MM



Kod	Açıklama	Kutu Adet	Koli Adet	Fiyat
DMX4229	300 mm	30	60	2,63 \$

Budama Testeresi Ağaç Saplı Oval / 300mm

- ▶ Isıl İşlem Uygulanmış Dişler
- ▶ Yüksek Karbon Çelik
- ▶ Üç Eksenli Özel Bileme
- ▶ 50 Rockwell Yay Çeliği



Kılıflı

300 MM



Kod	Açıklama	Kutu Adet	Koli Adet	Fiyat
DMX4226	300 mm	30	60	4,58 \$

Budama Testeresi Pvc Saplı Oval 330mm

- ▶ Isıl İşlem Uygulanmış Dişler
- ▶ Yüksek Karbon Çelik
- ▶ Üç Eksenli Özel Bileme



330 MM



Kod	Açıklama	Kutu Adet	Koli Adet	Fiyat
DMX4224	330 mm	1	48	3,66 \$

Budama Testeresi Sap Takmalı 330mm

- ▶ Isıl İşlem Uygulanmış Dişler
- ▶ Yüksek Karbon Çelik
- ▶ Üç Eksenli Özel Bileme



Sap Takmalı

330 MM



Kod	Açıklama	Kutu Adet	Koli Adet	Fiyat
DMX4225	330 mm	24	48	4,53 \$

Dijital El Kantarı 40 KG



MAKSİMUM
40
KG

Pilli Çalışma
LCD Led Ekran

Kod	Açıklama	Kutu Adet	Koli Adet	Fiyat
DMX4220	40 Kg	50	100	3,13 \$

Profesyonel Dijital El Kantarı 50 KG



MAKSİMUM
50
KG

Pilli Çalışma
LCD Led Ekran

Kod	Açıklama	Kutu Adet	Koli Adet	Fiyat
DMX4219	50 Kg	50	100	3,90 \$

Hassas Masa Terazisi 10 KG



MAKSİMUM
10
KG

Pilli Çalışma
LCD Led Ekran
Hassas Ölçüm

Kod	Açıklama	Kutu Adet	Koli Adet	Fiyat
DMX4221	10 Kg	1	40	3,17 \$

Dijital Hassas Terazî Hazneli 5 KG



MAKSİMUM
5
KG

Pilli Çalışma
LCD Led Ekran
Hassas Ölçüm

Kod	Açıklama	Kutu Adet	Koli Adet	Fiyat
DMX4222	5 Kg	1	24	7,94 \$

Dijital Hassas Terazî Profesyonel 500 grm



MAKSİMUM
500
GR

Pilli Çalışma
LCD Led Ekran
Hassas Ölçüm

0.1 gr
Hassasiyet

Kod	Açıklama	Kutu Adet	Koli Adet	Fiyat
DMX4218	500 gr	25	50	6,83 \$

Hassas Cep Terazî Dijital Profesyonel 200 gr



MAKSİMUM
200
GR

Pilli Çalışma
LCD Led Ekran
Hassas Ölçüm

0.1 gr
Hassasiyet

Kod	Açıklama	Kutu Adet	Koli Adet	Fiyat
DMX4217	200 gr	25	100	4,85 \$



Dijital Termometre Isı ve Nem Ölçer

Dijital
Blisterli Ambalaj

- Oda içerisindeki ortam sıcaklığını, nemini ölçer
- İdeal sıcaklığı yakalamanızda yardımcı olur
- Nem probu ile daha hassas ölçüm
- Ekran üzerinde saat ve tarih göstergesi ile kolaylık sağlar

Kod	Açıklama	Kutu Adet	Koli Adet	Fiyat
DMX4653	Dijital	50	150	3,83 \$

Dijital Multimetre Ölçü Aleti

Yük Korumalı
3/2/1 Basamaklı
LCD Max 1999 Okuma

- Akım Kademeli
- Ac Voltaj Kademeli
- Dc Voltaj Kademeli
- Direnç Ölçüm Kademeli
- Buzzer Özellikli
- Kısa Devre Kontrolü

Kod	Açıklama	Kutu Adet	Koli Adet	Fiyat
OZS-8664	Dijital	1	100	4,71 \$

Fonksiyonlu Dijital Multimetre Ölçü Aleti

LCD Ekran
3/2/1 Basamaklı
Ses Bildirimli
LCD Max 1999 Okuma
Yük Korumalı
Düşük Pil Göstergesi

- Akım Direnç Ölçüm Kademeli
- Dc Voltaj Kademeli
- Diyot ve Transistor Testi
- Düşük Pil göstergesi
- Otomatik Kutup Göstergesi
- Kısa Devre Kontrolü



Kod	Açıklama	Kutu Adet	Koli Adet	Fiyat
OZS-9434	Fonksiyonlu	1	60	8,17 \$



Yetkili Servislerimiz

İL	SERVİS ADI	ADRES	TELEFON
İstanbul	Merkez Servis - Çözüm El Aletleri	Altınşehir Mah Kumru Cad. No:35 B	0216 729 29 81
Adana	Erol Teknik - Erol Uyğul	Karasoku Mah 28012 Sok No-10/B	0533 362 24 15
Afyonkarahisar	Kardeş Bobinaj Elektrik - Murat Asal	Veysel Karani Mah.1135 Sokak No:26/A	0532 397 79 04
Ağrı	Mak-tek Servis ve El Aletleri - Uğur Berat Yıldırım	Güven Apt Altı Gök Hamamı Karşısı	0537 649 41 70
Amasya	Deniz Bobinaj - Musa Çam	Hacılar Meydanı Mah. Akıncılar Sk. No: 17/B	0543 952 57 91
Ankara	Anı Mak.Elk.Bob.Hırd.İnş.lth.lhc.San. ve Tic.A.ş.	1199 Sokak No:28 Ostim	0312 354 76 24
Ankara	Yavuz Makina - Levent Yavuz	Saray Mah. Fatih Sultan Mehmet Blv.no: 368 A Kahramankazan / Ankara	0538 351 30 84
Antalya	Antmak Elek.Bob.Elk.El Alt.Tam.Bak.Yed.Par.Ser.Hiz.	Şafak Mah. Akdeniz San.sit.5025 Sok. No:7	0546 203 35 18
Aydın	Enerji Teknik Bobinaj - Ekrem Karabulut	Yeni Mahalle 819 Sokak Bidan Apartmanı No:2/b	0544 811 43 70
Aydın	Özen Bobinaj - Tolga Kılıcı	Ata Mah. Tepecik Bulvarı No: 76	0256 227 07 07
Balıkesir	Emek Bobinaj - Emrah Onur	17 Eylül Mah.ataatürk Cad.no:235/b	0536 893 72 89
Bingöl	Ümit Bobinaj	Ş.mustafa Gündoğdu Mah. Bayındırlık Cad.ss Esnaf Tücc.koop. Galericiiler Sit. No:38	0544 842 58 00
Bolu	Garanti Bob. Elek. Elektronik Oto Yedek Parça	Sanayi Sitesi 28.blok No:2	0374 215 51 23
Bursa	Güney Kaynak Rob. ve Oto.Sis.End.Hır.TicSan.Ltd.Şti.	Alaaddin Bey Mah. 647 Sk. Zer6 Plaza No : 1b/d	0224 363 14 44
Bursa	E-Tedarik - Elif Yımsel	Beşevler Mah. Güllü 130 S. Melih Kent Sit. D Blok No:11 İç Kapı No:Z/1 Nilüfer/ Bursa	0543 229 49 82
Çorum	Emek Bobinaj - Emre Altunkeser	Çorum Sanayi Sitesi 37.sokak No 4	0364 234 68 84
Edirne	Eray Bobinaj - Mustafa Eray Tuğrul	Küçük Sanayi Sitesi 4. Blok No: 14	0284 225 26 92
Erzurum	Tolga Makine- Eyüp Tolga Sudaş	Bakırcı Mah. Cennet Çeşme Skyaşam Apt. No:6/e	0442 235 63 64
Eskişehir	Eskişehir Bobinaj Hırd. Elektrik İnş. San. Tic. Ltd. Şti	Şirintepe Mahallesi Kayacı Sokak No:1/b	0542 677 64 10
Gaziantep	Karavaşin Ticaret & Bobinaj - Mustafa Karavaşin	Küsget Sanayi Sitesi Anafartalar Bulvarı No :46	0544 202 06 50
Giresun	Sarı Grup - Volkan Sarı	Çıtlakkale Mah. Sönmez Cad. No: 99/b Merkez	0545 573 28 28
Hatay	Bal Bobinaj - Ahmet Bal	Yeni Sanayi Sitesi 5.cadde 51/b Blok No:7	0532 693 68 66
Hatay	Özdemir Bobinaj-hüseyin Murat Özdemir	Muradiye Mah. 320/1 Sokak No:29	0326 616 52 54
Mersin	Adem Coşkun Bobinaj	İhsaniye Mahallesi Havuzlar Caddesi Tekli Aprt No 51 E Akdeniz / Mersin	0535 505 64 01
İstanbul	Altek Mekatronik - Mehmet Altay	İçmeler Mah.altunay Sok.no:1/a	0216 494 03 43
İstanbul	Birlik Alektromekanik - Ali Şakrakdil	Perpa Tic. Mrk. B Blok Kat: 4 No : 318	0212 222 94 18-66
İstanbul	Çelik Makina - Asım Çelik	Aydıntepe Mah Geçit Sokak No: 28	0555 926 91 94
İstanbul	Ermak Grup Tek.serve Yapı Ürn. San.tic.ltd.şti.	Altınşehir Mah.alemdağ Cad. No:626/a	0216 540 46 28
İstanbul	Osga Bobinaj ve Elektrik- Sacit Geltetik	Ali Paşa Mah.fatih Sultan Mehmet Cad. Sancak Özsoy San.sit.no:6/49	0541 362 29 40
İstanbul	Yavuz Makina - Osman Taşçı	İosb Giyim Sanatkarları İş Ve Ticaret Merkezi 4. Ada A Blok No: 5 Başakşehir / İstanbul	0506 475 25 67
İstanbul	Özyıldız Teknik Bobinaj - Kadir Yıldız	Mimarsinan Merkez Mahallesi Tecimen Sanayi Sitesi No:12/a	0532 640 87 61
İstanbul	Sevnur Bobinaj - Özcan Öztürk	Eseneşehir Mah. Nato Yolu Cad.ilham Sokak No:10b	0216 527 87 67
İstanbul	Zenmak Makina Servis Hizmetleri San. Tic. Ltd. Şti.	İosb Demirciler Sitesi. C2 Blok Başakşehir No:212	0533 725 59 61
İzmir	İrfan Bobinaj - İrfan Makineci	1310 Sk. No:41/b Çankaya	0232 425 35 49
İzmir	Ulusal Teknik Servis - Mustafa Ulusal	Gıda Çarşısı Baltalı İş Merkezi 1203 Sk. No:18-c Konak	0232 469 35 33
Kastamonu	Teknik Bobinaj - Hakan Hasanbaş	İnönü Mah. İnebolu Cad.sanayi Çarşısı No:132	0366 212 62 26
Kocaeli	Özteknik Bobinaj Makina San. Tic. Ltd. Şti.	Gaziler Mah. İbrahim Ağa Cad. No: 159/a	0536 580 10 96
Kütahya	Kudret Bobinaj - Kudret Eğilmez	Fuat Paşa Mah.yeni Sanayi Sitesi 19.sok. No:30	0507 230 00 14
Kahramanmaraş	Bayram Bobinaj - Duran Bayram	Yavuz Selim Mah.yeni San. Sit.73004.cad.no:31/a	0344 231 08 26
Niğde	Emek Motor - Ferruh Çankaya	Eski San. Sit. 1.blok No: 2	0388 232 83 59
Rize	Çemberci Bobinaj İklim. Sist.San. ve Tic.Ltd. Şti.	Engindere Mah. Sanayi Sitesi F Blok No: 20	0464 217 45 00
Samsun	Akış Bobinaj - Evren Bayramkaya	Sanayi Sitesi Ulus Cad. No:31/b	0362 238 07 23
Tekirdağ	Çetin Elk. Bobinaj - Erol Çetin	100. Yıl Mah. Mehmet İlhan Sokak No:12/1c	0282 263 86 60
Tekirdağ	Özyıl Elektrik Endüstriyel Servis - Kurtuluş Yıldırım	Gazi Osman Paşa Mah. Aliağa Sk. No: 4a	0282 726 67 04
Tokat	Çetin Elektrik Bobinaj - Mustafa Çetin	Sanayi Sitesi Cami Altı No: 22	0356 214 63 07
Şanlıurfa	Ay Elektrik - Mehmet Emin Nimetoğlu	Kadroğlu Mah.vali Fuat Cad. Samsat Kapı Avşaroğlu Garajı No: 7	0414 215 74 76
Uşak	Akbulut Bobinaj - Görkem Akbulut	İslice Mah. 1. Bereket Sk.göğeroğlu İşhanı No:1/e	0553 560 01 54
Van	Kutlu Elektronik Ve Bobinaj-nuri Kutlu	Ercişli Emrah Sokak Algekiç Psj.no:20	0432 214 83 13
Aksaray	Çelikler El Aletleri - Emirhan Çelik	Bahçesaray Mahallesi 8634 Sk No:1/k K9 Blok	0533 497 33 05
Yalova	Umut Kaynak Teknolojileri San. Ltd. Şti.	Tersaneler Bölgesi Mevkii 10.sok. No:2/22	0535 283 44 97

TR **DMAX**[®]

POWER and HAND TOOLS

HER ÖLÇÜDE GÜVEN

PROFESYONELLER İÇİN

DAYANIKLI • HASSAS • ERGONOMİK



ABS
GÖVDE



HASSAS
ÖLÇÜM



KONFORLU
KULLANIM

Ömer Acar
Katalog Tasarım
0545 581 29 45



Çağrı Merkezi 0 8 5 0
840 92 34

2026

LIMITED EDITION

Ürün ve Fiyat Listesi